

The Vermont Stormwater Management Manual

Volume I - Stormwater Treatment Standards



**Vermont Agency of Natural Resources
April 2002**

5th Printing

The Vermont Stormwater Management Manual

Volume I – Stormwater Treatment Standards

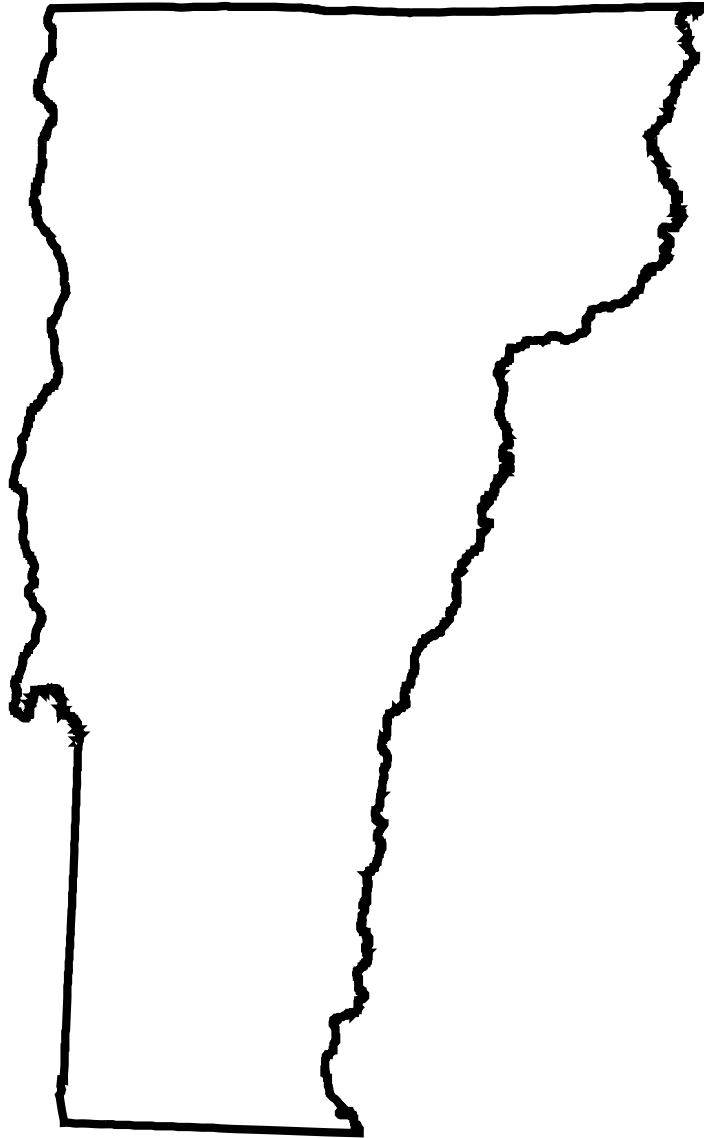

Vermont Agency of Natural Resources
April, 2002

5th Printing

The Vermont Department of Environmental Conservation is an equal opportunity agency and offers all persons the benefits of participating in each of its programs and competing in all areas of employment regardless of race, color, religion, sex, national origin, age, disability, sexual preference, or other non-merit factors.

This document is available upon request in large print, Braille or audio cassette.

VT Relay Service for the Hearing Impaired
1-800-253-0191 TDD>Voice – 1-800-253-0195 Voice>TDD

The Vermont Stormwater Management Manual

Volume I - Vermont Stormwater Treatment Standards

The Vermont Stormwater Management Manual consists of two volumes, Volume I – Vermont Stormwater Treatment Standards; and Volume II – Vermont Stormwater Management Manual. Volume I contains the regulatory requirements for the management of stormwater, and Volume II consists primarily of technical guidance to assist in the design of stormwater treatment practices.

This volume is organized as follows:

Section 1. Stormwater Treatment Practice (STP) Sizing Criteria

This section sets forth required stormwater treatment standards and design criteria for water quality, groundwater recharge, channel protection, overbank flood protection and extreme flood control. This Section presents a comprehensive approach for sizing stormwater treatment practices to meet these required standards. Finally, this Section sets forth certain exemptions to the treatment standards for channel protection, overbank flood protection and extreme flood control.

Section 2. Acceptable Stormwater Treatment Practices

This section sets forth stormwater treatment practices that are acceptable to meet the treatment standards set forth in Section 1. These stormwater treatment practices may be used alone, or in combination, to meet the required treatment standards. This Section also sets forth a process whereby a permit applicant may propose the use of alternative stormwater treatment practices.

Section 3. Voluntary Stormwater Management Credits

This section provides six groups of nonstructural practices that can be used to gain stormwater credits that will significantly reduce the cost and size of the stormwater treatment practices at a site. The key benefit of these non-structural practices is that they reduce the generation of stormwater runoff at a site, thereby resulting in decreased treatment and storage volumes. These nonstructural practices are completely voluntary and need not be used by a permit applicant.

ACKNOWLEDGEMENTS

The information contained in this manual was developed for the Vermont Agency of Natural Resources by a project team consisting of the Center for Watershed Protection, Aquafor Beech, Ltd. and Step by Step.

TABLE OF CONTENTS

| | |
|--|----------|
| SECTION 1 - STORMWATER TREATMENT PRACTICE SIZING CRITERIA | 1 |
| 1.0 INTRODUCTION..... | 1 |
| 1.1 TREATMENT STANDARDS | 3 |
| 1.1.1 <i>Water Quality Treatment Standard (WQTS)</i> | 3 |
| 1.1.2 <i>Channel Protection Treatment Standard</i> | 4 |
| 1.1.3 <i>Groundwater Recharge Treatment Standard</i> | 6 |
| 1.1.4 <i>Overbank Flood Protection Treatment Standard</i> | 9 |
| 1.1.5 <i>Extreme Flood Protection Treatment Standard</i> | 10 |
| 1.2 DOWNSTREAM ANALYSIS FOR QP10 AND QP100 | 11 |
| 1.3 CP_v STORAGE VOLUME CALCULATION | 12 |
| 1.3.1 <i>Storage Volume Estimation</i> | 12 |
| 1.3.2 <i>Water Quality Peak Flow Calculation</i> | 15 |
| SECTION 2 - ACCEPTABLE STORMWATER TREATMENT PRACTICES (STPS) | 1 |
| 2.0 INTRODUCTION..... | 1 |
| 2.1 ACCEPTABLE STPS..... | 1 |
| 2.2 WATER QUALITY STPS | 1 |
| 2.3 GROUNDWATER RECHARGE STPS | 4 |
| 2.4 STRUCTURAL STPS THAT MEET WATER QUANTITY REQUIREMENTS (CHANNEL PROTECTION AND FLOOD CONTROL) AND PRETREATMENT FUNCTIONS FOR MEETING WATER QUALITY TREATMENT STANDARD | 5 |
| 2.5 ALTERNATIVE STP DESIGNS | 5 |
| 2.5.1 <i>Existing Alternative Systems</i> | 5 |
| 2.5.2 <i>New-Design Alternative Systems</i> | 6 |
| 2.6 STORMWATER HOTSPOTS | 6 |
| 2.7 MINIMUM DESIGN CRITERIA FOR STPS..... | 7 |
| 2.7.1 <i>Stormwater Ponds</i> | 8 |
| 2.7.1.A. Pond Feasibility | 14 |
| 2.7.1.B. Pond Conveyance | 14 |
| 2.7.1.C. Pond Pretreatment..... | 15 |
| 2.7.1.D. Pond Treatment | 16 |
| 2.7.1.E. Pond Landscaping..... | 17 |
| 2.7.1.F. Pond Maintenance..... | 18 |
| 2.7.1.G. Cold Climate Pond Design Considerations..... | 20 |
| 2.7.2 <i>Stormwater Wetlands</i> | 22 |
| 2.7.2.A. Wetland Feasibility..... | 27 |
| 2.7.2.B. Wetland Conveyance | 27 |
| 2.7.2.C. Wetland Pretreatment..... | 27 |
| 2.7.2.D. Wetland Treatment..... | 27 |
| 2.7.2.E. Wetland Landscaping | 30 |
| 2.7.2.F. Wetland Maintenance..... | 30 |
| 2.7.2.G. Cold Climate Design Considerations | 30 |
| 2.7.3 <i>Stormwater Infiltration Practices</i> | 31 |
| 2.7.3.A. Infiltration Feasibility | 34 |
| 2.7.3.B. Infiltration Conveyance | 34 |
| 2.7.3.C. Infiltration Pretreatment..... | 35 |
| 2.7.3.D. Infiltration Treatment | 36 |
| 2.7.3.E. Infiltration Landscaping..... | 37 |

| | |
|---|-----------|
| 2.7.3.F. Infiltration Maintenance..... | 37 |
| 2.7.3.G. Cold Climate Design Considerations | 37 |
| <i>2.7.4 Stormwater Filtering Systems.....</i> | <i>39</i> |
| 2.7.4.A. Filtering Feasibility | 45 |
| 2.7.4.B. Filtering Conveyance..... | 45 |
| 2.7.4.C. Filtering Pretreatment | 45 |
| 2.7.4.D. Filtering Treatment..... | 47 |
| 2.7.4.E. Filtering Landscaping | 48 |
| 2.7.4.F. Filtering Maintenance | 48 |
| 2.7.4.G. Cold Climate Design Considerations | 49 |
| <i>2.7.5 Open Channel Systems.....</i> | <i>50</i> |
| 2.7.5.A. Open Channel Feasibility | 54 |
| 2.7.5.B. Open Channel Conveyance..... | 54 |
| 2.7.5.C. Open Channel Pretreatment | 54 |
| 2.7.5.D. Open Channel Treatment..... | 55 |
| 2.7.5.E. Open Channel Landscaping | 55 |
| 2.7.5.F. Open Channel Maintenance | 55 |
| 2.7.5.G. Cold Climate Design Considerations | 56 |
| 2.8 LIMITED APPLICABILITY STORMWATER MANAGEMENT PRACTICES | 56 |
| SECTION 3 – VOLUNTARY STORMWATER MANAGEMENT CREDITS..... | 1 |
| 3.0 INTRODUCTION..... | 1 |
| 3.1 NATURAL AREA CONSERVATION CREDIT..... | 2 |
| 3.2 DISCONNECTION OF ROOFTOP RUNOFF CREDIT..... | 3 |
| 3.3 DISCONNECTION OF NON-ROOFTOP RUNOFF CREDIT..... | 6 |
| 3.4 STREAM BUFFER CREDIT | 7 |
| 3.5 GRASS CHANNEL CREDIT..... | 9 |
| 3.6 ENVIRONMENTALLY SENSITIVE RURAL DEVELOPMENT CREDIT | 11 |
| 3.7 DEALING WITH MULTIPLE CREDITS..... | 13 |
| 3.8 OTHER STRATEGIES TO REDUCE IMPERVIOUS COVER | 13 |
| GLOSSARY | 1 |
| REFERENCES | 1 |

LIST OF FIGURES

| | |
|---|----|
| FIGURE 1.1 APPROXIMATE RANGES FOR STORMS COMPRISING UNIFIED SIZING CRITERIA | 1 |
| FIGURE 1.2 RELATIONSHIP BETWEEN RECHARGE REQUIREMENT AND SITE IMPERVIOUS COVER | 7 |
| FIGURE 1.3 GRAPHICAL DEPICTION OF COINCIDENT PEAK PHENOMENA (ARC, 2001) | 11 |
| FIGURE 1.4 UNIT PEAK DISCHARGE FOR TYPE II RAINFALL DISTRIBUTION (SOURCE: NRCS, 1986) | 13 |
| FIGURE 1.5 DETENTION TIME VS. DISCHARGE RATIOS (SOURCE: ADOPTED FROM HARRINGTON, 1987) .. | 14 |
| FIGURE 1.6 APPROXIMATE DETENTION BASIN ROUTING FOR RAINFALL TYPES I, IA, II, AND III. (SOURCE: NRCS, 1986) | 15 |
| FIGURE 2.1 EXAMPLE OF MICROPOOL EXTENDED DETENTION POND (P-1) | 9 |
| FIGURE 2.2 EXAMPLE OF WET POND (P-2) | 10 |
| FIGURE 2.3 EXAMPLE OF WET EXTENDED DETENTION POND (P-3) | 11 |
| FIGURE 2.4 EXAMPLE OF MULTIPLE POND SYSTEM (P-4) | 12 |
| FIGURE 2.5 EXAMPLE OF POCKET POND (P-5) | 13 |
| DESIGN VARIATION | 16 |
| FIGURE 2.6 SEASONAL OPERATION POND (SOURCE: OBERTS, 1994) | 21 |
| FIGURE 2.7 EXAMPLE OF SHALLOW WETLAND (W-1) | 23 |
| FIGURE 2.8 EXAMPLE OF EXTENDED DETENTION SHALLOW WETLAND (W-2) | 24 |
| FIGURE 2.9 EXAMPLE OF POND/WETLAND SYSTEM (W-3) | 25 |
| FIGURE 2.10 EXAMPLE OF GRAVEL WETLAND (W-4) | 26 |
| FIGURE 2.11 EXAMPLE OF INFILTRATION TRENCH (I-1) | 32 |
| FIGURE 2.12 EXAMPLE OF INFILTRATION BASIN (I-2) | 33 |
| FIGURE 2.13 SEASONAL OPERATION INFILTRATION FACILITY (SOURCE: OBERTS, 1994) | 38 |
| FIGURE 2.14 EXAMPLE OF SURFACE SAND FILTER (F-1) | 40 |
| FIGURE 2.15 EXAMPLE OF UNDERGROUND SAND FILTER (F-2) | 41 |
| FIGURE 2.16 EXAMPLE OF PERIMETER SAND FILTER (F-3) | 42 |
| FIGURE 2.17 EXAMPLE OF ORGANIC FILTER (F-4) | 43 |
| FIGURE 2.18 EXAMPLE OF BIORETENTION (F-5) | 44 |
| FIGURE 2.19 EXAMPLE OF DRY SWALE (O-1) | 51 |
| FIGURE 2.20 EXAMPLE OF WET SWALE (O-2) | 52 |
| FIGURE 2.21 EXAMPLE OF GRASS CHANNEL (O-3) | 53 |
| FIGURE 2.22 EXAMPLE OF DRY DETENTION POND (LA-1) | 58 |
| FIGURE 2.23 EXAMPLE OF UNDERGROUND STORAGE VAULT (LA-2) | 59 |
| FIGURE 2.24 EXAMPLE OF HYDRODYNAMIC DEVICE (LA-3) | 60 |
| FIGURE 2.25 EXAMPLE OF OIL AND GRIT SEPARATORS (LA-4) | 61 |
| FIGURE 2.26 EXAMPLE OF FILTER STRIP (LA-5) | 62 |
| FIGURE 3.1 SCHEMATIC OF DRY WELL (SOURCE: ADAPTED AFTER HOWARD COUNTY, MD) | 4 |
| FIGURE 3.2 SCHEMATIC OF ROOFTOP DISCONNECTION CREDIT | 5 |
| FIGURE 3.3 EXAMPLE OF STREAM BUFFER CREDIT OPTION | 8 |
| FIGURE 3.4 SCHEMATIC OF GRASS CHANNEL CREDIT | 10 |
| FIGURE 3.5 SCHEMATIC OF ENVIRONMENTALLY SENSITIVE RURAL DEVELOPMENT CREDIT | 12 |
| FIGURE 3.6 EXAMPLE OF CONVENTIONAL RETAIL SITE DESIGN | 15 |
| FIGURE 3.7 EXAMPLE OF IMPROVED RETAIL SITE DESIGN | 16 |

LIST OF TABLES

| | |
|---|----|
| TABLE 1.1 REQUIRED STORMWATER TREATMENT STANDARDS AND SIZING CRITERIA | 2 |
| TABLE 1.2 RAINFALL DEPTHS ASSOCIATED WITH THE 1-YEAR, 2-YEAR, 10-YEAR, AND 100-YEAR, 24-HOUR STORM EVENT | 4 |
| TABLE 2.1 LIST OF PRACTICES ACCEPTABLE FOR WATER QUALITY TREATMENT | 2 |
| TABLE 2.2 LIST OF PRACTICES ACCEPTABLE FOR RECHARGE REQUIREMENT | 4 |
| TABLE 2.3 CLASSIFICATION OF STORMWATER HOTSPOTS | 7 |
| TABLE 2.4 WATER QUALITY VOLUME DISTRIBUTION IN POND DESIGNS | 16 |
| TABLE 2.5 WATER QUALITY VOLUME AND SURFACE AREA DISTRIBUTION IN STORMWATER WETLAND DESIGN VARIANTS..... | 29 |
| TABLE 2.6 GUIDELINES FOR FILTER STRIP PRETREATMENT SIZING..... | 46 |

Section 1 - Stormwater Treatment Practice Sizing Criteria

1.0 Introduction

Effective stormwater management must include both water quality and water quantity controls. This section presents a unified approach for designing and sizing stormwater treatment practices (STPs) to meet specified treatment standards for water quality, channel protection, groundwater recharge, overbank flood protection and extreme flood control. The unified sizing approach is intended to manage the entire frequency of storms anticipated over the life of the stormwater management system and the associated development. These include storms ranging from the smallest, most frequent storm events that produce little or no runoff, but make up the majority of individual storm events and are responsible for the majority of groundwater recharge, up to the largest, very infrequent storm events that can cause catastrophic damage. (See Figure 1.1)

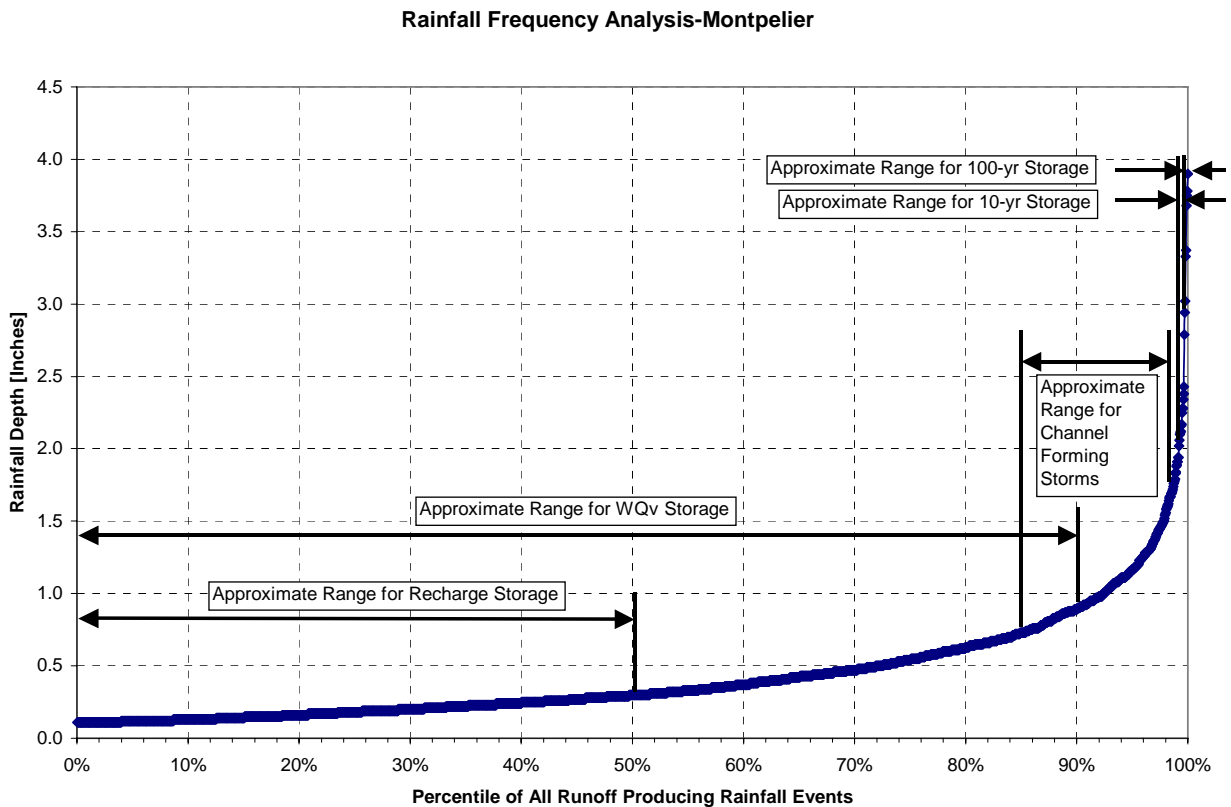

Figure 1.1 Approximate Ranges for Storms Comprising Unified Sizing Criteria

STPs must be chosen and designed to meet the treatment standards set forth in this section for water quality, groundwater recharge, channel protection, overbank flood protection and extreme flood control. These treatment standards are summarized in Table 1.1. This section also sets forth certain exemptions to the treatment standards for channel protection, overbank flood protection and extreme flood control.

Table 1.1 Required Stormwater Treatment Standards and Sizing Criteria

| Criteria | Sizing Requirement | | | | | | | | |
|---------------------------------------|---|---|-------------------------------|---|-------------------------------|---|-------------------------------|---|--------|
| Water Quality (WQ _v) | <p>90% Rule:</p> $WQ_v = [(P)(R_v)(A)] / 12$ <p style="text-align: right;">expressed in acre-feet when A has units of acres</p> <p>where:</p> <p>P = 0.9 inches</p> <p>R_v = Runoff Coefficient = [0.05+0.009(I)]</p> <p>I = Impervious Cover (whole number percent)</p> <p>A = Site (area in acres)</p> <p>Note: Minimum WQ_v = 0.2 inches (0.0167 ac-ft.)</p> | | | | | | | | |
| Recharge (Re _v) | <p>Hydrologic Soil Group¹ Recharge Requirement</p> <table style="margin-left: auto; margin-right: auto;"> <tr> <td style="padding-right: 20px;">A</td> <td>0.40 inches x impervious area</td> </tr> <tr> <td>B</td> <td>0.25 inches x impervious area</td> </tr> <tr> <td>C</td> <td>0.10 inches x impervious area</td> </tr> <tr> <td>D</td> <td>waived</td> </tr> </table> | A | 0.40 inches x impervious area | B | 0.25 inches x impervious area | C | 0.10 inches x impervious area | D | waived |
| A | 0.40 inches x impervious area | | | | | | | | |
| B | 0.25 inches x impervious area | | | | | | | | |
| C | 0.10 inches x impervious area | | | | | | | | |
| D | waived | | | | | | | | |
| Channel Protection (CP _v) | <p>Default Criterion:</p> <p>CP_v = 12 hours extended detention of post-developed 1-year, 24-hour rainfall event in coldwater fish habitats (24 hr. detention in warmwater fish habitats).</p> | | | | | | | | |
| Overbank Flood (Q _{p10}) | <p>Control the post-developed² peak discharge from the 10-year storm to 10-year pre-development³ rates.</p> | | | | | | | | |
| Extreme Storm (Q _{p100}) | <p>Control the peak discharge from the 100-year storm to 100-year pre-development rates.</p> | | | | | | | | |

Section 2 of this Manual sets forth acceptable STPs for use in meeting these stormwater treatment standards and describes required design elements that must be used in designing STPs. Section 2 also

¹ Standard Hydrologic Soil Groups as categorized by NRCS

² Post development is defined as the land use represented by a project after development

³ The standard for characterizing pre-development land use for on-site areas shall be woods, meadow, or pasture in good condition. For agricultural land, assume pasture in good condition.

provides guidance design elements that may be used in designing STPs. The Vermont Stormwater Management Manual, Volume II-Technical Guidance provides further guidance for choosing STPs, overall site design and STP design. The Vermont Stormwater Management Manual, Volume II-Technical Guidance includes examples of hypothetical developments (e.g. Cole's Colony in Appendix C-1) and guides the reader through the calculation of applicable storage volumes.

1.1 Treatment Standards

1.1.1 Water Quality Treatment Standard (WQTS)

The objective of the WQTS is to capture 90 percent of the annual storm events, and to remove 80 percent of the average annual post development total suspended solids load (TSS), and 40 percent of the total phosphorus (TP) load. The following water quality treatment standards must be met for all new and existing development:

1. For new development and expansion of existing impervious surfaces, employment of the practices presented in Table 2.1, will meet the water quality objective.
2. For redevelopment, either:
 - a. the existing impervious surface shall be reduced by 20%; or
 - b. a STP shall be designed to capture and treat 20% of the water quality volume from the existing impervious area; or
 - c. a combination of a. or b. that when combined equal a minimum 20% reduction/treatment.

The following equation shall be used to determine the water quality storage volume (WQ_v) (in acre-feet of storage):

$$WQ_v = \frac{(P) (R_v) (A)}{12}$$

where:

- WQ_v = water quality volume (in acre-feet)
 P = 90% Rainfall Event (0.9 inches across Vermont)
 R_v = volumetric runoff coefficient equal to: $[0.05 + 0.009(I)]$, where I is a whole number percent impervious cover at the site (ex. 25, not .25)
 A = site area (in acres)

In association with the 90% rule, a minimum WQ_v value of 0.2 watershed inches is required to treat the runoff from pervious surfaces on sites with low impervious cover⁴.

⁴ Sites with low impervious cover that are not exempt from the stormwater management criteria will typically be able to meet the water quality requirement through the use of stormwater credits (see Section 3 of the Vermont Stormwater Treatment Standards).

In evaluating water quality volume and STPs for water quality treatment, the following criteria shall be applied:

- Impervious cover shall be measured from the site plan and shall include all areas that do not have permanent vegetative or permeable cover. Impervious cover is defined as manmade surfaces, including, but not limited to, paved and unpaved roads, paved and unpaved parking areas, roofs, driveways, and walkways from which precipitation runs off rather than infiltrates.
- The final WQ_v shall be treated by an acceptable STP from the list presented in Tables 2.1 and 2.2 of section 2 unless an alternative STP design is accepted by the Agency of Natural Resources (Agency) as described in section 2.5.
- Where nonstructural STPs are employed in the site design, the WQ_v volume can be reduced in accordance with the stormwater credits described in section 3.
- Water quality treatment for off-site areas that may drain to a STP is not required.
- The water quality treatment standard can be met by providing 24-hour extended detention of the WQ_v (provided a micro-pool is specified, see section 2). A micropool is designed so that the extended detention volume is released over a 24-hour period. This storm should be routed separately from the channel protection (CP_v) storm (i.e. volumes are additive).

1.1.2 Channel Protection Treatment Standard

To protect stream channels from degradation, storage of the channel protection volume (CP_v) shall be provided by means of 12 to 24 hours of extended detention storage (ED) for the one-year, 24-hour rainfall event. If a stormwater discharge is to a coldwater fish habitat, 12 hours of extended detention is required and if a stormwater discharge is to a warmwater fish habitat, 24 hours of extended detention is required. Coldwater fish habitats and warm water fish habitat designations are listed in the Vermont Water Quality Standards.

The rainfall depth for use in channel protection calculations will vary depending on project location. In Vermont, the one-year, 24-hour rainfall ranges between 2 and 2.4 inches (NOAA, TP 40, 1961). Rainfall depths for the one-year, 24-hour storm event are provided in Table 1.2 on a County-by-County basis. Site designers should use the value provided in Table 1.2 unless specific data are available for a particular site location and prior approval has been obtained from the Agency.

Table 1.2 Rainfall Depths Associated with the 1-Year, 2-Year, 10-Year, and 100-Year, 24-Hour Storm Event

| Vermont County | 1-yr, 24-Hr Rainfall Depth | 2-yr, 24-Hr Rainfall Depth | 10-yr, 24-Hr Rainfall Depth | 100-yr, 24-hr Rainfall Depth |
|-----------------------|-----------------------------------|-----------------------------------|------------------------------------|-------------------------------------|
| Addison | 2.2 | 2.4 | 3.4 | 5.4 |
| Bennington | 2.3 | 2.8 | 4.0 | 6.8 |
| Caledonia | 2.2 | 2.3 | 3.1 | 5.4 |
| Chittenden | 2.1 | 2.3 | 3.2 | 5.2 |
| Essex | 2.2 | 2.3 | 3.1 | 5.1 |

| Vermont County | 1-yr, 24-Hr Rainfall Depth | 2-yr, 24-Hr Rainfall Depth | 10-yr, 24-Hr Rainfall Depth | 100-yr, 24-hr Rainfall Depth |
|----------------|-------------------------------|-------------------------------|--------------------------------|---------------------------------|
| Franklin | 2.1 | 2.3 | 3.1 | 5.2 |
| Grand Isle | 2.1 | 2.2 | 3.1 | 5.1 |
| Lamoille | 2.1 | 2.4 | 3.4 | 5.4 |
| Orange | 2.2 | 2.4 | 3.4 | 5.7 |
| Orleans | 2.1 | 2.2 | 3.1 | 5.0 |
| Rutland | 2.3 | 2.5 | 3.7 | 5.9 |
| Washington | 2.2 | 2.4 | 3.4 | 5.4 |
| Windham | 2.3 | 2.8 | 4.0 | 6.8 |
| Windsor | 2.3 | 2.5 | 3.7 | 5.9 |

In evaluating channel protection volume and STPs for channel protection, the following criteria shall be applied:

- Channel protection (CP_v) storage shall be calculated and designed for independently of the WQ_v. However, where extended detention is being used as a water quality treatment component, routing through the treatment practice can use a composite stage-discharge relationship. In addition, where an offline treatment practice is used to treat only the water quality volume, an additional facility is necessary to manage the full channel protection volume (that is, CP_v and WQ_v shall be provided separately).
- Channel protection volume shall be calculated by considering the runoff from both on-site and also any off-site drainage contributing to the point of discharge.
- If offsite runoff is rerouted, the designer must ensure that such rerouting will not cause channel erosion or flooding problems in the area where the water is discharged.
- The models TR-55 or TR-20 (or approved equivalent⁵) shall be used for determining peak discharge rates.
- Rainfall depths for the one-year, 24-hour storm event are provided in Table 1.2.
- Off-site areas shall be modeled as "present condition" for the one-year storm event.
- The length of overland flow used in time of concentration (t_c) calculations shall be typically limited to no more than 100 feet for post-developed conditions. However, this length can be increased to 150 feet if pervious off-site area is part of the contributing drainage area and a component of the t_c calculation.
- The CP_v storage volume shall be computed using methodology developed by Harrington (1987) (see section 1.3 below) or by an equivalent methodology for small area hydrology.
- The CP_v shall be released at a roughly uniform rate over the required release period, with the goal of achieving the requisite detention time between the inflow and outflow mass centroids. When using the Harrington method as described in section 1.3, it is presumed that this target detention time is being met.

⁵ "Approved equivalent" models for computing peak discharges are acceptable, given the stipulation that the methodology must use a "storage-indication" routing method for pond routing.

- Orifices less than three inches shall be protected from clogging (See illustration in Appendix D5 of the Vermont Stormwater Management Manual, Volume II-Technical Guidance). The minimum recommended orifice size is one inch. Site designers only need to provide the detention time provided by the one-inch minimum orifice size.
- For projects that have disconnected the majority of impervious surfaces per use of the credits in Section 3 such that routing to a detention facility is not achieved, the designer may use an alternative design standard. In these cases, the designer shall demonstrate that the post-developed peak discharge from the disconnected portion of the site for the one-year storm is no greater than the peak discharge from the same portion of the site as modeled as if 12-hour detention were provided.

The treatment standard for channel protection shall be waived for:

1. Expansions involving less than or equal to one (1) acre of impervious cover;
2. A site where the pre-routed post-development discharge is less than 2 cubic feet per second; or
3. A site that directly discharges to a waterbody with a drainage area equal to or greater than 10 square miles, and that is less than 5% of the watershed area at the site's upstream boundary;

1.1.3 Groundwater Recharge Treatment Standard

The average annual recharge rate for the prevailing hydrologic soil group(s) (HSG) shall be maintained in order to preserve existing water table elevations. Recharge volume (Re_v) is determined as a function of annual predevelopment recharge for a given soil group, average annual rainfall volume, and amount of impervious cover at a site.

The groundwater recharge treatment standard shall be satisfied by one of two methods or a combination of both. The first is designated as the "Percent Volume Method," and is based on infiltrating the recharge volume using one or more approved structural STPs (see Tables 2.1 and 2.2 in section 2). The second method is designated as the "Percent Area Method," and is based on draining runoff from some or all of the site impervious area through one or more approved nonstructural STPs (See Table 2.2 in section 2).

The Percent Volume Method calculation is as follows:

$$Re_v = (F)(A)(I)/12$$

Where: Re_v = Recharge volume (acre-feet)

F = Recharge factor (inches)

Hydrologic Soil Group

Recharge Factor (F)

A 0.40

B 0.25

C 0.10

D waived

A = Site area (in acres)

I = Site imperviousness (expressed as a decimal percent)

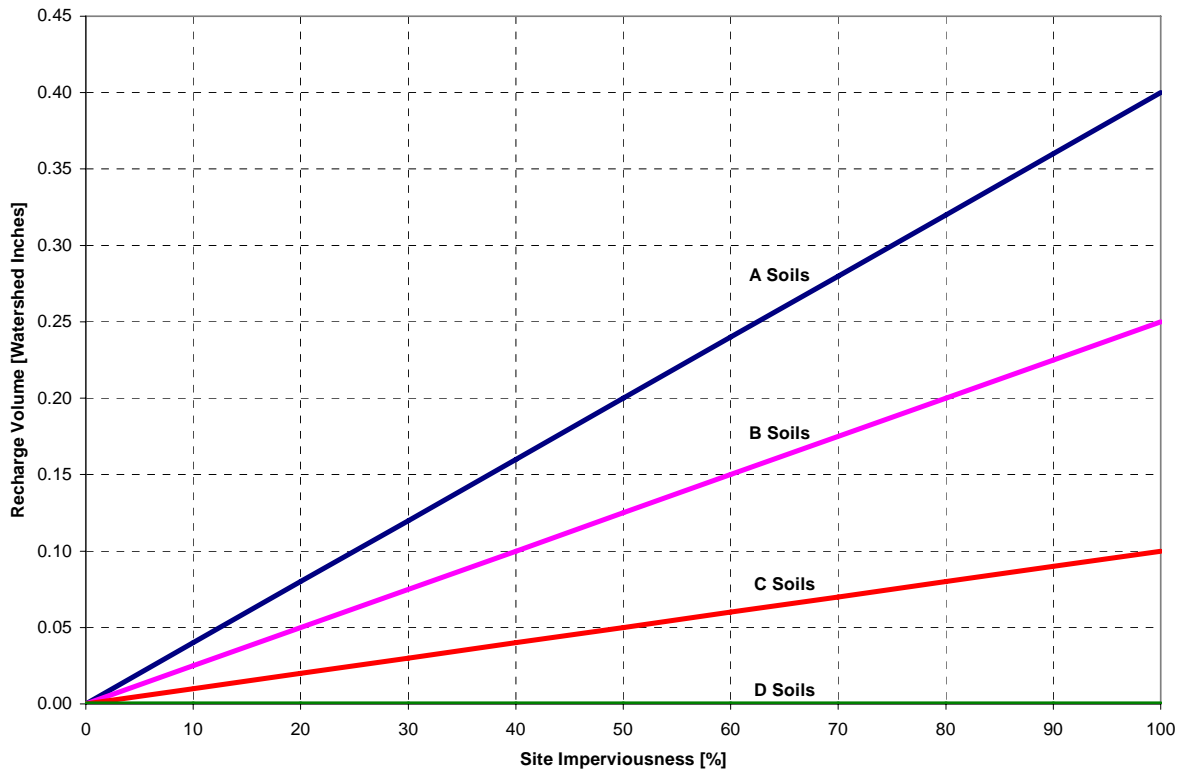

Figure 1.2 Relationship Between Recharge Requirement and Site Impervious Cover

Figure 1.2 illustrates the recharge volume requirements as a function of hydrologic soil group type and site impervious cover (expressed in watershed inches).

In cases where the “Percent Volume Method” is used, and the entire site does not drain to the STP used, the Designer shall use the “Percent Area Method” to verify that an adequate area drains to the STP.

The Percent Area Method calculation is as follows:

$$Re_a = (F)(A)(I)$$

Where: Re_a = Recharge area requiring treatment (acres)

F = Recharge factor (dimensionless)

| Hydrologic Soil Group | Recharge Factor (F) |
|-----------------------|---------------------|
| A | 0.40 |
| B | 0.25 |
| C | 0.10 |
| D | waived |

A = Site area in acres

I = Site imperviousness (expressed as a decimal percent)

The recharge volume is considered part of the total water quality volume that must be provided at a site (i.e. Re_v is contained within WQ_v) and can be achieved by a structural practice. The required recharge area (Re_a) is equivalent to the recharge volume and can be achieved by a non-structural practice (e.g. infiltration of sheet flow from disconnected impervious surfaces). In addition, a combination of both of the methods can be used to meet the recharge requirement at a site (see the stormwater credits discussion in section 3).

If an applicant elects to utilize both the Percent Volume and Percent Area Methods to meet the recharge requirement, the following applies:

1. Calculate both the Re_v and Re_a for the site.
2. The site impervious area draining to an approved nonstructural STP is subtracted from the Re_a calculation from 1 above;
3. The remaining Re_a is divided by the original Re_a to calculate a pro-rated percentage that needs to be met by the Percent Volume Method;
4. The pro-rated percent is multiplied by the original Re_v to calculate a new Re_v that must be met by an approved structural STP.

The groundwater recharge treatment standard shall be waived for:

1. Stormwater runoff from hotspot land uses (as described in section 2.6).
2. Stormwater recharge may be prohibited or otherwise restricted within groundwater recharge areas, wellhead protection areas, or where certain unusual geological features may exist such as karst topographic areas; areas of documented slope failure, or redevelopment projects.
3. No subsurface infiltration of stormwater will be allowed within 500' of a public community water supply or non-transient non-community water supply.

NOTES:

- 1) Horizontal and vertical dimensions (depth): Note the horizontal dimension must be greater than the vertical dimension to qualify for a discharge permit under this application.
- 2) Identify all drinking water supplies within 300 feet of the drainage well on a site plan. **Note: Locating a drainage well within 100 feet of a drinking water supply is prohibited.**
- 3) Identify distance from bottom of drainage well to seasonal high groundwater.

1.1.4 Overbank Flood Protection Treatment Standard

The post-development peak discharge rate shall not exceed the pre-development peak discharge rate for the 10-year, 24-hour storm event.

It is recommended that a downstream analysis be conducted as described in section 1.2. The Agency will waive the 10-year control requirement on a case-by-case basis where the developer demonstrates that there will be no increase in flood threat downstream to the point of the "so-called" 10% rule (see section 1.2 for the requirements of a downstream analysis.) This will always require that an applicant perform downstream hydrologic/hydraulic analyses.

In evaluating overbank flood protection and related STPs, the following criteria shall be applied:

- For expansions of previously non-permitted projects, the site shall mean the expanded portion of the site including all areas within the limits of construction.
- Overbank flood control storage is calculated and designed for independently of the CP_v and WQ_v . However, routing through the treatment practice can use a composite stage-discharge relationship. In addition, where an offline treatment practice is used to treat only the water quality volume, an additional facility is necessary to manage the full overbank flood control volumes.
- The models TR-55 and TR-20 (or approved local equivalent) will be used for determining peak discharge rates, and for routing detention ponds.
- The standard for characterizing pre-development land use for on-site areas shall be woods, meadow, or pasture in good condition. For agricultural land, a curve number representing pasture in good condition should be used.
- Off-site areas should be modeled as "present condition."
- For safe passage of the 100-year event, off-site areas that drain to the STP should be modeled as "ultimate condition⁶."
- The length of overland sheet flow used in time of concentration calculations is limited to no more than 150 feet for predevelopment conditions and 100 feet for post development conditions. This length can be increased to 150 feet if pervious off-site area is part of the contributing drainage area and a component of the t_c calculation.
- Table 1.2 indicates the depth of rainfall (24-hour) associated with the 10-year and 100-year storm events for all Vermont counties.

⁶ Ultimate condition reflects full build-out based on existing zoning. Where zoning has not been established, ultimate condition should reflect reasonable professional judgment that considers the likely nature of land use for the subject lands projected into the future over a 30 to 40 year planning period. Review authorities should be consulted where zoning has not been established.

The treatment standard for overbank flood protection shall be waived if:

1. A site discharges directly to a large reservoir, lake, or stream with a drainage area greater than or equal to 10 square miles; or
2. The site is smaller than five (5) acres and the channel has adequate capacity to convey the post-development 10-year discharge downstream to the point of the so-called 10% rule; and downstream conveyance systems have adequate capacity to convey the 10-year storm.

1.1.5 Extreme Flood Protection Treatment Standard

The post-development peak discharge rate shall not exceed the pre-development peak discharge rate for the 100-year, 24-hour storm event. The purpose of this treatment standard is to prevent flood damage from infrequent but very large storm events, maintain the boundaries of the pre-development 100-year floodplain, and protect the physical integrity of a STP.

In evaluating extreme flood control and related STPs, the following criteria shall be applied:

- For expansions of previously non-permitted projects, the site shall mean the expanded portion of the site including all areas within the limits of construction.
- Extreme flood control storage is calculated and designed independently of the CP_v and WQ_v . However, routing through the treatment practice can use a composite stage-discharge relationship. In addition, where an offline treatment practice is used to treat only the water quality volume, an additional facility is necessary to manage the full extreme flood control volume.
- The models TR-55 and TR-20 (or approved local equivalent) will be used for determining peak discharge rates, and for routing detention ponds.
- The standard for characterizing pre-development land use for on-site areas shall be woods, meadow, or pasture in good condition. For agricultural land, a curve number representing pasture should be used.
- Off-site areas should be modeled as "present condition."
- For safe passage of the 100-year event, off-site areas that drain to the STP should be modeled as "ultimate condition⁷".
- The length of overland sheet flow used in time of concentration calculations shall be limited to no more than 150 feet for predevelopment conditions and 100 feet for post development conditions. This length can be increased to 150 feet if pervious off-site area is part of the contributing drainage area and a component of the t_c calculation.
- Table 1.2 indicates the depth of rainfall (24-hour) associated with the 10-year and 100-year storm events for all Vermont counties.

⁷ Ultimate condition reflects full build-out based on existing zoning. Where zoning has not been established, ultimate condition should reflect reasonable professional judgment that considers the likely nature of land use for the subject lands projected into the future over a 30 to 40 year planning period. Review authorities should be consulted where zoning has not been established.

The treatment standard for extreme flood control shall be waived if the following conditions exist:

1. The site discharges directly to a reservoir, lake, or stream with a drainage area greater than or equal to 10 square miles; or
2. The impervious area is less than 10 acres; or
3. A downstream analysis is conducted (See section 1.2) that indicates extreme flood control is not necessary for the site.

1.2 Downstream Analysis for Qp10 and Qp100

Depending on the shape and land use of a watershed, it is possible that upstream peak discharge may arrive at the same time a downstream structure is releasing its peak discharge, thus increasing the total discharge (see Figure 1.3). As a result of this “coincident peaks” problem, it is often necessary to evaluate conditions downstream from a site to ensure that effective out-of-bank control is being provided.

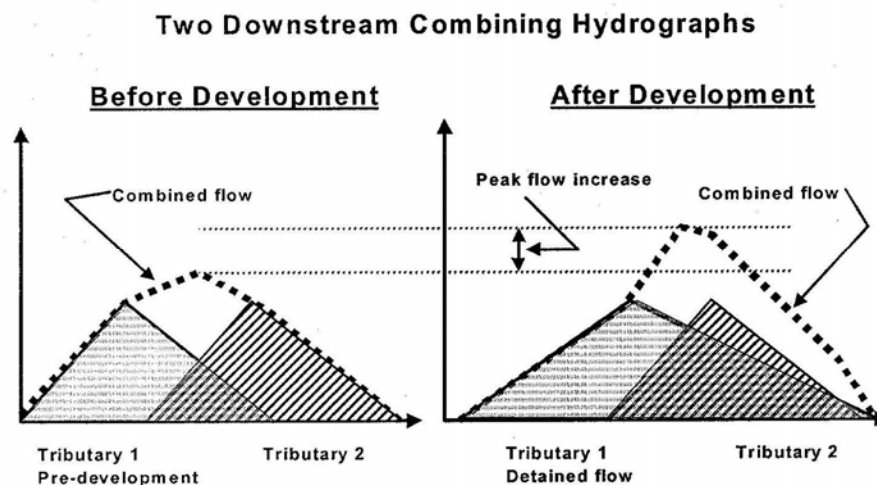

Figure 1.3 Graphical Depiction of Coincident Peak Phenomena (ARC, 2001)

A downstream analysis is required for projects over 50 acres and on-site impervious cover greater than 25%, or when deemed appropriate by the Agency (e.g., known drainage or flooding conditions or existing channel erosion is evident). The criteria used for the downstream analysis is referred to as the “10% rule”. Under the 10% rule, a hydrologic and hydraulic analysis is extended downstream to the point where the site represents 10% of the total drainage area. For example, a 60-acre site would be analyzed to the point downstream with a drainage area of 600 acres.

As a minimum, the analysis should include the hydrologic and hydraulic effects of all culverts and/or obstructions within the downstream channel and assess whether an increase in water surface elevations will impact existing buildings or other structures. The analysis should compute flow rates and velocities (for the overbank and extreme flood control storms) downstream to the location of the 10% rule for present conditions and proposed conditions (i.e., before and after development of the applicable site) both with and without the detention facility. If flow rates and velocities (for Qp10 and Qp100) with the proposed detention facility increase by less than 5% from the pre-developed

condition, and no existing structures are impacted, then no additional analysis is necessary. If the flow rates and velocities increase by more than 5%, then the designer should either redesign the detention structure, evaluate the effects of no detention structure, propose corrective actions to the impacted downstream areas, or utilize some combination of the above. Additional investigations may be required by the Agency on a case-by-case basis depending on the magnitude of the project, the sensitivity of the receiving water resource, or other issues such as past drainage or flooding complaints.

Special caution should be employed where the analysis shows that no detention structure is required. Stormwater designers must be able to demonstrate that runoff will not cause downstream flooding within the stream reach to the location of the 10% rule. The absence of on-site detention shall not be perceived to waive or eliminate groundwater recharge (Re_v), water quality control (WQ_v), or stream channel protection requirements (CP_v).

A typical downstream analysis will require a hydrologic investigation of the site area draining to a proposed detention facility and of the contributing watershed to the location of the 10% rule for the 10- and, possibly, 100-year storms. A hydraulic analysis of the stream channel below the facility to the location of the 10% rule will also be necessary (e.g., a HECRAS water surface profile analysis). Depending on the magnitude of the impact and the specific conditions of the analysis, additional information and data may be necessary such as collecting field run topography, establishing building elevations and culvert sizes or investigating specific drainage concerns or complaints.

1.3 CP_v storage volume calculation

This section presents two hydrologic and hydraulic analysis tools that can be used to size stormwater treatment practices (STPs). The first is the TR-55 “short-cut” sizing technique, used to size practices designed for extended detention, slightly modified to incorporate the flows necessary to provide channel protection. The second is a method used to determine the peak flow from water quality storm events. (This is often important when the water quality storm is diverted to a water quality practice, with other larger events bypassed).

1.3.1 Storage Volume Estimation

This section presents a modified version of the TR-55 (NRCS, 1986) short cut sizing approach. The method was modified by Harrington (1987) for applications where the peak discharge is very small compared with the uncontrolled discharge. This often occurs in the 1-year, 24-hour detention sizing. Using TR-55 guidance, the unit peak discharge (q_u) can be determined based on the Curve Number and Time of Concentration (Figure 1.4). Knowing q_u and T (extended detention time), q_o/q_i (peak outflow discharge/peak inflow discharge) can be estimated from Figure 1.5.

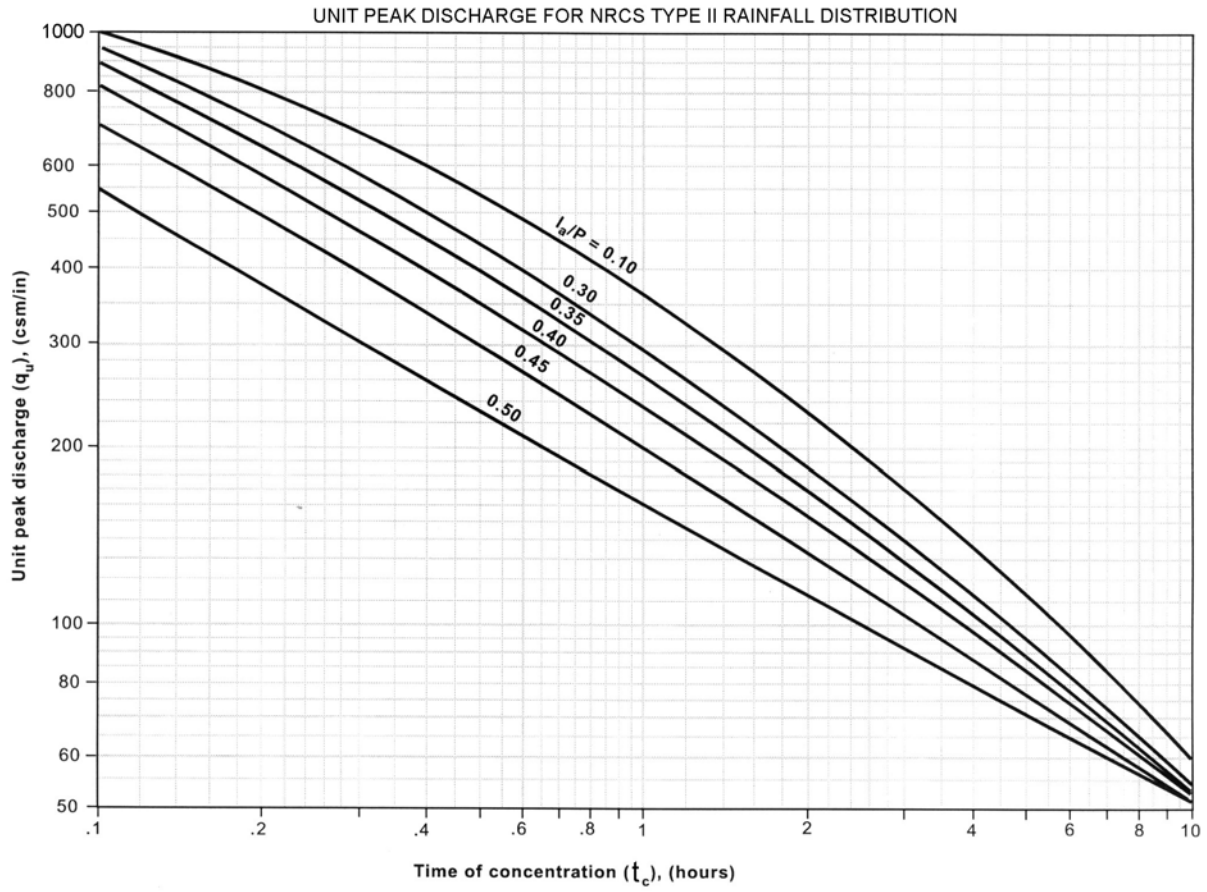

Figure 1.4 Unit Peak Discharge for Type II Rainfall Distribution (Source: NRCS, 1986)

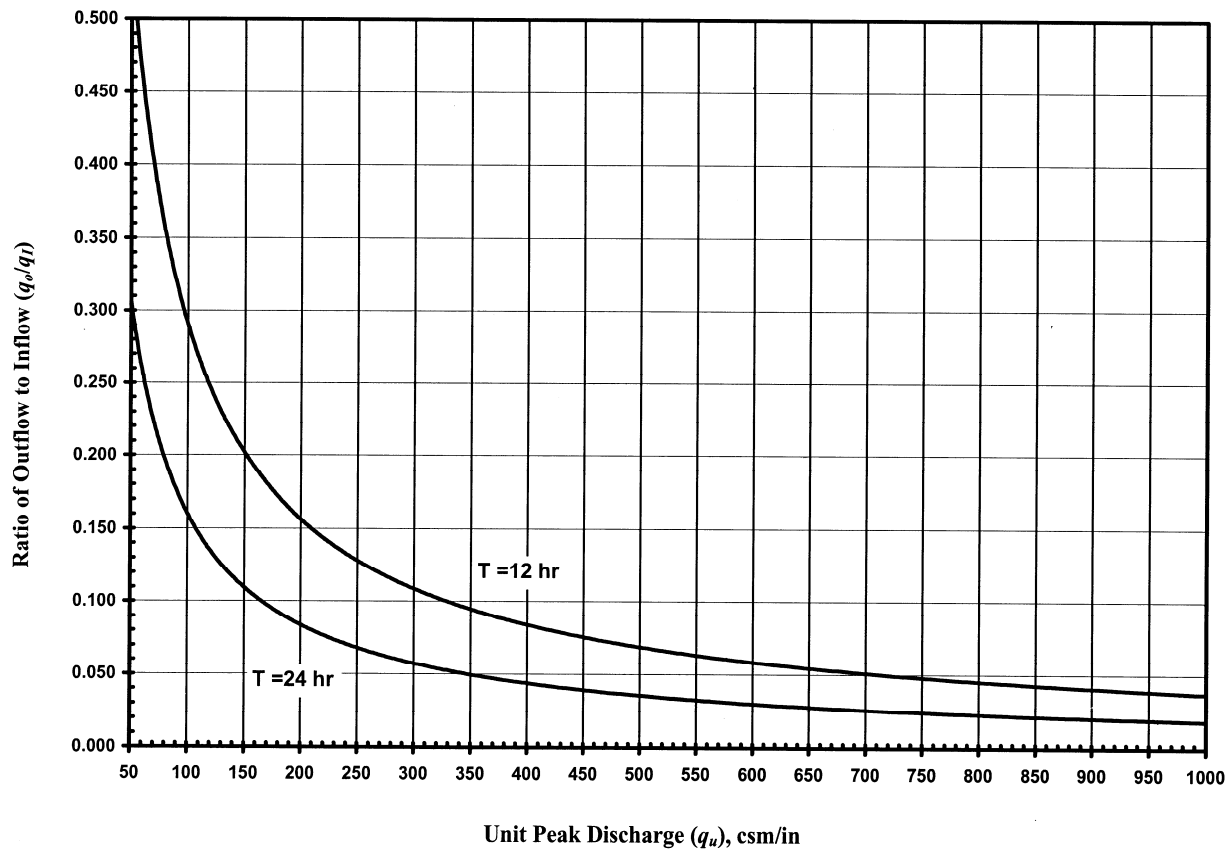

Figure 1.5 Detention Time vs. Discharge Ratios (Source: adopted from Harrington, 1987)

Then using q_o/q_i , Figure 1.6 can be used to estimate V_s/V_r . For a Type II or Type III rainfall distribution, V_s/V_r can also be calculated using the following equation:

$$V_s/V_r = 0.682 - 1.43 (q_o/q_i) + 1.64 (q_o/q_i)^2 - 0.804 (q_o/q_i)^3$$

- Where:
- V_s = required storage volume (acre-feet)
 - V_r = runoff volume (acre-feet)
 - q_o = peak outflow discharge (cfs)
 - Q_i = peak inflow discharge (cfs)

The required storage volume can then be calculated by:

$$V_s = \frac{(V_s/V_r)(Q_d)(A)}{12}$$

- Where:
- Q_d = the developed runoff for the design storm (inches)
 - A = total drainage area (acres)

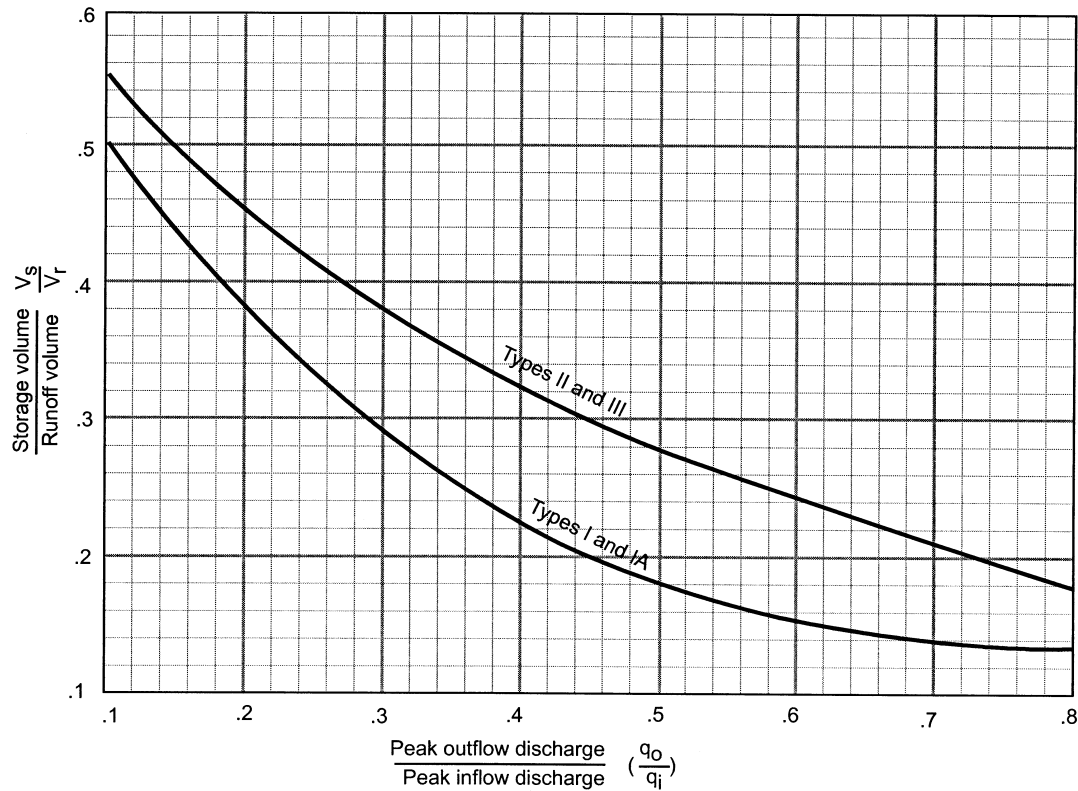

Figure 1.6 Approximate Detention Basin Routing For Rainfall Types I, IA, II, and III. (Source: NRCS, 1986)

1.3.2 Water Quality Peak Flow Calculation

The peak rate of discharge for the water quality design storm is needed for the sizing of off-line diversion structures, such as sand filters and grass channels. Conventional NRCS methods have been found to underestimate the volume and rate of runoff for rainfall events less than 2". This discrepancy in estimating runoff and discharge rates can lead to situations where a significant amount of runoff bypasses the filtering treatment practice due to an inadequately sized diversion structure and can lead to the design of undersized bypass channels.

The following procedure can be used to estimate peak discharges for small storm events. It relies on the water quality volume and a modified approach to the NRCS peak flow estimating method. A brief description of the calculation procedure is presented below.

Using the water quality volume (WQ_V), a corresponding Curve Number (CN) is computed utilizing the following equation:

$$CN = 1000/[10 + 5P + 10Q_a - 10(Q_a^2 + 1.25 Q_a P)^{1/2}]$$

where

| | | |
|-------|---|--|
| P | = | rainfall, in inches (use the Water Quality Storm depth) |
| Q_a | = | runoff volume, in inches (equal to $WQ_V \div \text{area}$) |

Once a CN is computed, the time of concentration (t_c) is computed (based on the methods identified in TR-55 and section 1 of this Manual).

Using the computed CN, t_c and drainage area (A), in acres; the peak discharge (Q_{wq}) for the water quality storm event is computed as follows.

Read initial abstraction (I_a), compute I_a/P

Read the unit peak discharge (q_u) for appropriate t_c

Using the water quality volume (WQ_V), compute the peak discharge (Q_{wq})

$$Q_{wq} = q_u * A * WQ_V$$

where

| | | |
|----------|---|---|
| Q_{wq} | = | the peak discharge, in cfs |
| q_u | = | the unit peak discharge, in cfs/mi ² /inch |
| A | = | drainage area, in square miles |
| WQ_V | = | Water Quality Volume, in watershed inches |

Section 2 - Acceptable Stormwater Treatment Practices (STPs)

2.0 Introduction

This section covers structural and non-structural practices for meeting treatment requirements (section 1), including:

- Structural STPs (ponds, stormwater wetlands, infiltration practices; filtering systems, and open channels);
- Non-structural STPs (rooftop disconnection, sheetflow, swales, etc.);
- Required design criteria and design guidelines; and
- Requirements for use of alternative STPs.

2.1 Acceptable STPs

This section outlines STPs that can be used to meet the water quality; water quantity and groundwater recharge treatment standards set forth in section 1. These acceptable STPs can be used alone, or in combination, to meet the required treatment standards.

2.2 Water Quality STPs

This section sets forth STPs that meet the water quality treatment performance standard. These STPs were selected based on the following criteria:

1. They can capture and treat the full water quality volume (WQ_v).
2. They are capable of removing approximately 80% total suspended solids (TSS) and 40% total phosphorus (TP) removal.⁸
3. They have acceptable performance and longevity in the field.

Acceptable water quality practices are divided into five broad groups, including:

- **Stormwater Ponds**⁹ Practices that have a combination of permanent pool and extended detention capable of treating the WQ_v.

⁸ The 80% removal target is a management measure developed by EPA as part of the Coastal Zone Act Reauthorization Amendments of 1990 (USEPA, 1993). It was selected by EPA for the following factors: (1) removal of 80% is assumed to control heavy metals, phosphorus, and other pollutants; (2) a number of states including DE, FL, TX, MD, and MA require/recommend TSS removal of 80% or greater for new development; and (3) data show that certain BMPs, when properly designed and maintained, can meet this performance level. The 40% TP target recognizes the sensitivity of Vermont receiving waters, particularly Lake Champlain, to phosphorus loads.

⁹ Specific performance criteria and guidance for ponds and wetlands in cold water habitats are provided in this Section.

- **Stormwater Wetlands¹⁰** Practices that include significant shallow marsh areas, and may also incorporate small permanent pools or extended detention storage to achieve the full WQ_v .
- **Infiltration Practices** Practices that capture and temporarily store the WQ_v before allowing it to infiltrate into the soil.
- **Filtering Practices** Practices that capture and temporarily store the WQ_v and pass it through a filter bed of sand, organic matter, soil, or other media.
- **Open Channel Practices** Practices explicitly designed to capture and treat the full WQ_v within dry or wet cells formed by check dams or other means.

Table 2.1 summarizes the specific practices within each of these broad STP categories that should be used to meet the water quality treatment standards. For new development and expansion of existing development, employment of the practices presented in Table 2.1, will meet the water quality objectives of capturing and treating 90 percent of the annual storm events and to remove 80 percent of the average annual post development total suspended solids load (TSS) and 40 percent of the total phosphorus (TP) load. It is important to note that several practices that are not on the list may be of value as pretreatment, or to meet water quantity requirements (see discussion below).

Table 2.1 List of Practices Acceptable for Water Quality Treatment

| Group | Practice | Description |
|-------|---|--|
| Pond | Micropool ¹⁰ Extended Detention Pond | Pond that treats the majority of the water quality volume through extended detention ¹¹ , and incorporates a micropool at the outlet of the pond to prevent sediment resuspension. |
| | Wet Pond | Pond that provides storage for the entire water quality volume in the permanent pool. |
| | Wet Extended Detention Pond | Pond that treats a portion of the water quality volume by detaining storm flows above the permanent pool for a specified minimum detention time. |
| | Multiple Pond System | A group of ponds that collectively treat the water quality volume. |
| | Pocket Pond | A pond design adapted for the treatment of runoff from small drainage and which has little or no baseflow available to maintain water elevations and relies on groundwater to maintain a permanent pool. |

¹⁰ Micropool is the term to define a small permanent pool 4-8 feet deep, with a minimum storage of 20% of the water quality volume.

¹¹ Extended detention involves providing temporary storage above the permanent pool or micropool that is released over a specified period of time (e.g., 24 hours).

| Group | Practice | Description |
|---------------------|----------------------------|--|
| Wetland | Shallow Marsh | A wetland that provides water quality treatment primarily in a wet shallow marsh. |
| | Extended Detention Wetland | A wetland system that provides a portion of the water quality volume by detaining storm flows above the marsh surface. |
| | Pond/ Wetland System | A wetland system that provides a portion of the water quality volume in the permanent pool of a wet pond that precedes the shallow marsh wetland. |
| | Gravel Wetland | A wetland system composed of a wetland plant mat grown in a gravel or rock matrix. |
| Infiltration | Infiltration Trench | An infiltration practice that stores the water quality volume in the void spaces of a gravel trench before it is infiltrated into the ground. |
| | Infiltration Basin | An infiltration practice that stores the water quality volume in a shallow surface depression, before it is infiltrated into the ground. |
| Filtering Practices | Surface Sand Filter | A filtering practice that treats stormwater by settling out larger particles in a sediment chamber, and then filtering stormwater through a sand matrix. |
| | Underground Sand Filter | A filtering practice that treats stormwater as it flows through underground settling and filtering chambers. |
| | Perimeter Sand Filter | A filter that incorporates a shallow sediment chamber and filter bed as parallel vaults adjacent to a parking lot. |
| | Organic Filter | A filtering practice that uses an organic medium such as compost in the filter, or incorporates organic material in addition to sand (e.g., peat/sand mixture). |
| | Bioretention | A shallow depression that treats stormwater as it flows through a soil matrix, and is returned to the storm drain system. |
| Open Channels | Dry Swale | An open vegetated channel or depression explicitly designed to detain and promote the filtration of stormwater runoff into an underlying soil media. |
| | Wet Swale | An open vegetated channel or depression designed to retain water or intercept groundwater for water quality treatment. |
| | Grass Channel | An open vegetated channel or depression designed to convey and detain the water quality volume at a maximum velocity of 1 foot per second with a minimum residence time of 10 minutes. |

2.3 Groundwater Recharge STPs

Table 2.2 provides a list of structural and nonstructural STPs that meet the groundwater recharge treatment standards set forth in section 1. In all cases, groundwater recharge STPs will also meet that portion of the requisite water quality volume. The structural STPs are used for the Percent Volume Method described in section 1 and the nonstructural STPs are used for the Percent Area Method described in section 1. A combination of STPs can be used to meet the groundwater recharge treatment standard.

Table 2.2 List of Practices Acceptable for Recharge Requirement

| Type | Practice | Notes |
|-----------------------------------|---|--|
| Structural | Infiltration Trench | Practice explicitly designed for groundwater recharge |
| | Infiltration Basin | Practice explicitly designed for groundwater recharge |
| | Surface Sand Filter | Provides recharge only if designed as an exfilter ¹² system |
| | Organic Filter | Provides recharge only if designed as an exfilter system |
| | Bioretention | Provides recharge only if designed as an exfilter system |
| | Dry Swale | Provides recharge only if designed as an exfilter system |
| | Grass Channel | See section 2.7.5 for description and example calculation |
| Nonstructural (Design Credits) | Disconnection of Rooftop Runoff | See section 3.2 for description and example calculation |
| | Disconnection of Non-Rooftop Runoff | See section 3.3 for description and example calculation |
| | Sheetflow Runoff to Stream Buffer | See section 3.4 for description and example calculation |
| | Use of Open Vegetated Swales | See section 3.5 for description and example calculation |
| | Environmentally Sensitive Rural Development | See section 3.6 for description and example calculation |

¹² Where native soil conditions have adequate permeability, sedimentation chambers associated with filters can be designed to exfiltrate by having open or exposed bottoms. Similarly, bioretention facilities can be designed to exfiltrate by foregoing a perforated underdrain manifold.

2.4 Structural STPs That Meet Water Quantity Requirements (Channel Protection and Flood Control) and Pretreatment Functions for Meeting Water Quality Treatment Standard

Certain structural STPs can be used to meet water quantity requirements (e.g. channel protection and flood control) and can be used for pretreatment to meet the water quality treatment standard, but cannot be used alone as water quality STPs. For example, dry ponds, underground vaults and on-line storage in the storm drain network are acceptable STPs that provide stormwater detention to meet the channel protection, overbank flood protection and extreme flood control treatment standards set forth in section 1. These STPs are not acceptable to meet the water quality treatment standard (i.e. 80% TSS and 40% TP removal) and must be used with another STP to meet water quality.

Filter strips and oil and grit separators are also not “stand alone” water quality STPs, but may be used as pretreatment devices in combination with other STPs as pretreatment devices, to treat a small portion of a site, or to achieve stormwater design credits (See section 3).

2.5 Alternative STP Designs

The stormwater treatment field is rapidly evolving and new stormwater management technologies constantly emerge. A permit applicant may propose and the Agency may allow the use of STPs other than those listed in Tables 2.1 and 2.2 if the permit applicant can demonstrate to the Agency's satisfaction that the proposed alternative STPs will attain the applicable treatment performance standards for water quality, groundwater recharge, channel protection, overbank flood protection and extreme flood control. **Proposals for use of alternative treatment systems will require consideration of the design through the use of the individual permit application process.**

There are two methods by which a designer may propose an alternative system design evaluation: through consideration of an existing-alternative system, currently installed and being used for stormwater treatment in a similar climate; or through a new design-alternative system proposed for use in Vermont.

2.5.1 Existing Alternative Systems

If an existing-alternative STP is proposed, the permit applicant shall include independent scientific verification of its ability to meet the applicable treatment standards specified in section 1.1 and a proven record of longevity in the field. For an existing alternative STP to be considered by the Agency, the following monitoring criteria shall be included in supporting studies or a plan of study:

- At least five storm events must be sampled.
- Concentrations reported in the study must be flow-weighted.
- The study may be independently verified by the Agency.
- The study must be conducted in the field, as opposed to laboratory testing.
- The practice must have been in the ground for at least one year at the time of monitoring.

The Agency may also require further scrutiny of a proposed alternative STP based on the performance of similar STPs. For example, if a STP has a very similar design to an oil/grit separator, which has consistently poor removal, then a single study may not justify use of that STP as an approved water quality STP. Finally, the Agency may request evidence of long-term performance based on field applications. Among other things, a poor maintenance record or high failure rate is valid justification for the Agency's rejection of a STP.

If the Agency determines, after study by the permit applicant, that a proposed alternative STP design does not meet the performance standards, and the applicant is not able to modify the system to correct the deficiency to the satisfaction of the Agency within a reasonable period of time, then the permit applicant shall use the acceptable STPs set forth in this section. If a proposed alternative STP design is successfully approved by the Agency, then this alternative will be available for use by other permit applicants, if determined appropriate by the Agency.

2.5.2 New-Design Alternative Systems

The performance standard for STPs shall meet the applicable treatment standards specified in section 1.1, and shall have the capability to achieve long-term performance in the field. For an alternative STP to be submitted to the Agency for consideration, a designer's certification of compliance, including pertinent design information must be provided. This certification must provide details, with a reasonable level of surety, on how the system will achieve the requisite performance standards. In addition, a plan of study to obtain the following should be provided:

- At least five storm events must be sampled.
- Storm events must be sampled under a varying and representative range of precipitation intensities and antecedent conditions.
- Concentrations reported in the study must be flow-weighted.
- The study and/or design may be independently verified by the Agency.
- The study must be conducted in the field, as opposed to laboratory testing.
- The practice must have been in the ground for at least one year at the time of monitoring.
- The study must be completed within three years of construction.

If the Agency determines that a proposed alternative STP design does not meet the performance standards, and the applicant is not able to modify the system to correct the deficiency to the satisfaction of the Agency within a reasonable period of time, then the permit applicant shall utilize the acceptable STPs set forth in this section. If a proposed alternative STP design is successfully approved by the Agency, then this alternative will be available for use by other permit applicants, if determined appropriate by the Agency.

2.6 Stormwater Hotspots

A stormwater hotspot is defined as a land use or activity that generates higher concentrations of hydrocarbons, trace metals or toxicants than are found in typical stormwater runoff, based on monitoring studies. If a site, or a specific discharge point at a site, is designated as a hotspot, it has important implications for how stormwater is managed. First and foremost, stormwater runoff from hotspot discharges cannot be allowed to infiltrate into groundwater unless an individual stormwater permit is obtained from the Agency. Table 2.3 provides a list of designated hotspots for Vermont.

The Agency will issue a National Pollutant Discharge Elimination System (NPDES) multi-sector general permit in the near future for hotspot land uses in order to minimize pollutants entering stormwater. A permit applicant should check with the Agency regarding the status of this NPDES multi-sector general permit.

Table 2.3 Classification of Stormwater Hotspots

| |
|--|
| <p>The following land uses and activities are deemed <i>stormwater hotspots</i>:</p> <ul style="list-style-type: none"> ▪ Vehicle salvage yards and recycling facilities ▪ Vehicle fueling stations ▪ Vehicle service and maintenance facilities ▪ Vehicle and equipment cleaning facilities ▪ Fleet storage areas (bus, truck, etc.) ▪ Industrial sites (for SIC codes outlined in Appendix D4 of the Vermont Stormwater Management Manual, Volume II-Technical Guidance) ▪ Marinas (service and maintenance) ▪ Outdoor liquid container storage ▪ Outdoor loading/unloading facilities ▪ Public works storage areas ▪ Facilities that generate or store hazardous materials ▪ Commercial container nursery |
|--|

The following land uses and activities are **not** considered hotspots:

- Residential streets and rural highways
- Residential development
- Institutional development
- Office developments
- Non-industrial rooftops
- Pervious areas, except golf courses, garden centers, and nurseries (which may need stormwater pollution prevention plans and/or integrated pest management (ipm) plans).

2.7 Minimum Design Criteria for STPs

This section outlines minimum acceptable design criteria for five groups of structural STPs in order to meet the treatment standards set forth in section 1.1 for water quality, groundwater recharge, channel protection, overbank flood protection and extreme flood control. These STPs can be grouped into five general categories:

- Stormwater Ponds
- Stormwater Wetlands
- Infiltration Practices
- Filtering Systems
- Open Channels.

Required design elements are features that shall be used in all cases. Design guidelines are guidance features that could enhance practice performance, but may not be necessary in all cases. In the event that an exact numerical criterion specified within the various required design elements cannot be complied with precisely due to site constraints, the designer may use their best professional judgment to specify minor variations from numerical design criteria. However, these variations must be certified by the designer as being equivalent in performance to the required design element, and any such variation must be specifically identified in the Notice of Intent (NOI) letter to the Agency. The Agency will then have the option of either approving the variation on a case specific basis and allowing coverage under the general permit, or requiring the system to be considered as an 'alternative system' as described in section 2.5.

Finally, this section provides minimum design criteria and guidance for STPs that have limited applicability either because they only provide water quantity control capabilities (i.e. dry detention ponds and underground storage vaults) or because they have limited water quality treatment capabilities (i.e. hydrodynamic/swirl concentrator devices, oil/grit separators and filter strips).

Note: Any practice that creates an embankment (i.e. barrier to confine or raise water for storage or diversion) should follow the guidance presented in the dam standards and specifications (See Appendix B1 of the Vermont Stormwater Management Manual, Volume II-Technical Guidance) or comparable design specifications and may require a permit from the Dam Safety Section of the Agency.

2.7.1 Stormwater Ponds

Stormwater ponds are practices that have either a permanent pool of water, or a combination of a permanent pool and extended detention, and some elements of a shallow marsh equivalent to the entire WQ_v. Five design variants include:

| | | |
|-----|-----------------------------------|--------------|
| P-1 | Micropool Extended Detention Pond | (Figure 2.1) |
| P-2 | Wet Pond | (Figure 2.2) |
| P-3 | Wet Extended Detention Pond | (Figure 2.3) |
| P-4 | Multiple Pond System | (Figure 2.4) |
| P-5 | "Pocket" Pond | (Figure 2.5) |

Treatment Suitability: All five stormwater pond design variations can be used to provide channel protection volume as well as overbank and extreme flood attenuation. Dry extended detention ponds without a permanent pool are not considered an acceptable option for meeting water quality treatment goals; however, they may be appropriate to meet water quantity criteria.

The term "pocket" refers to a pond or wetland that has such a small contributing drainage area that little or no baseflow is available to sustain water elevations during dry weather. Instead, water elevations are heavily influenced and, in some cases, maintained by a locally high water table.

Potential cold climate design modifications that address the primary concerns associated with ponds in cold climates are provided at the end of this section. **The cold climate design modifications are presented as guidance only and are not required elements.** A more detailed discussion of cold climate modifications can be found in the publication Stormwater BMP Design Supplement for Cold Climates (Caraco & Claytor, 1997).

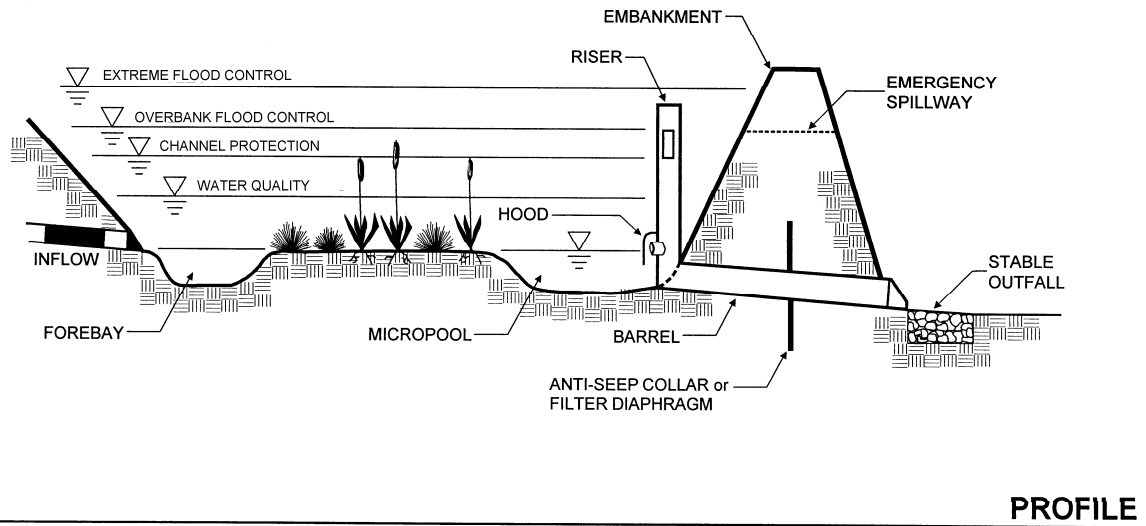
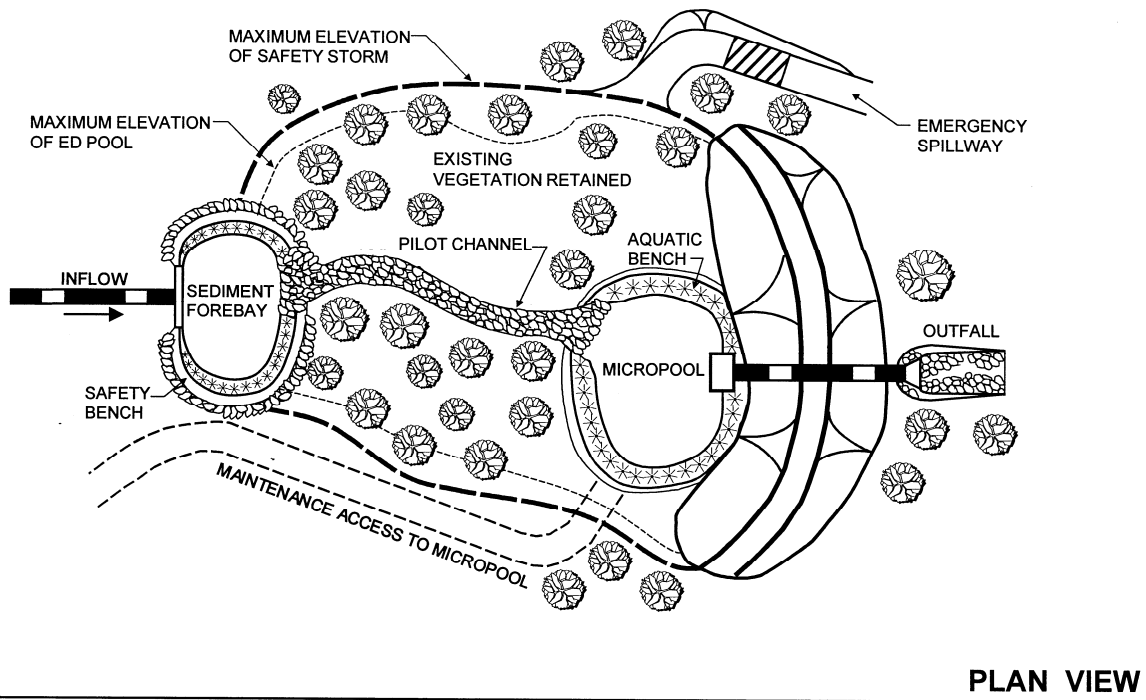
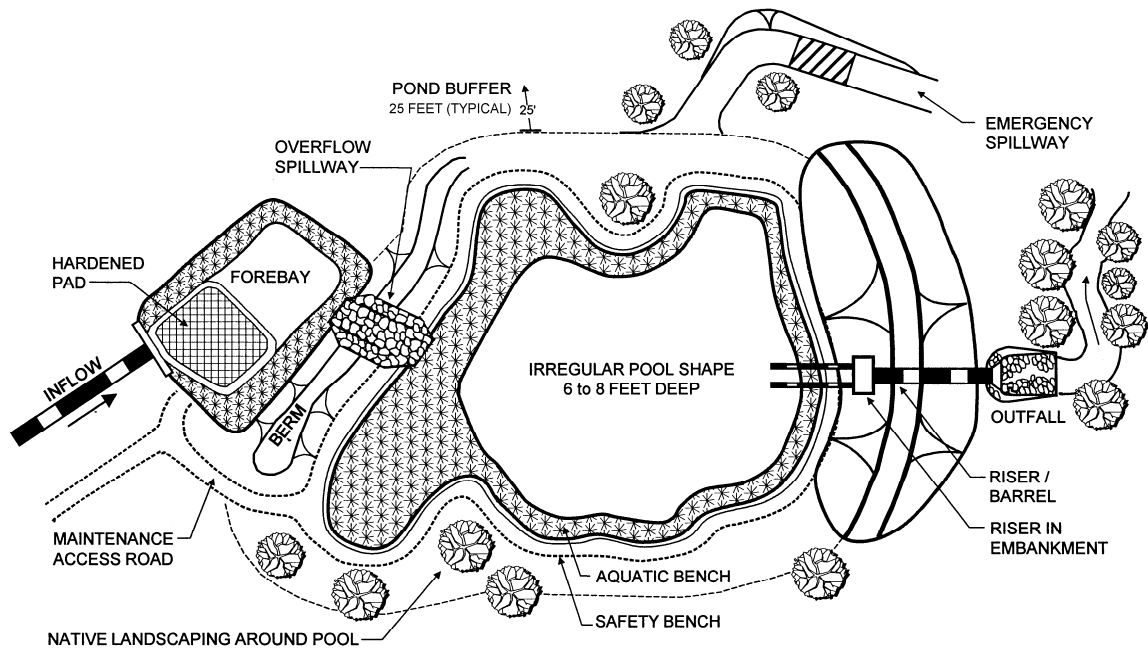
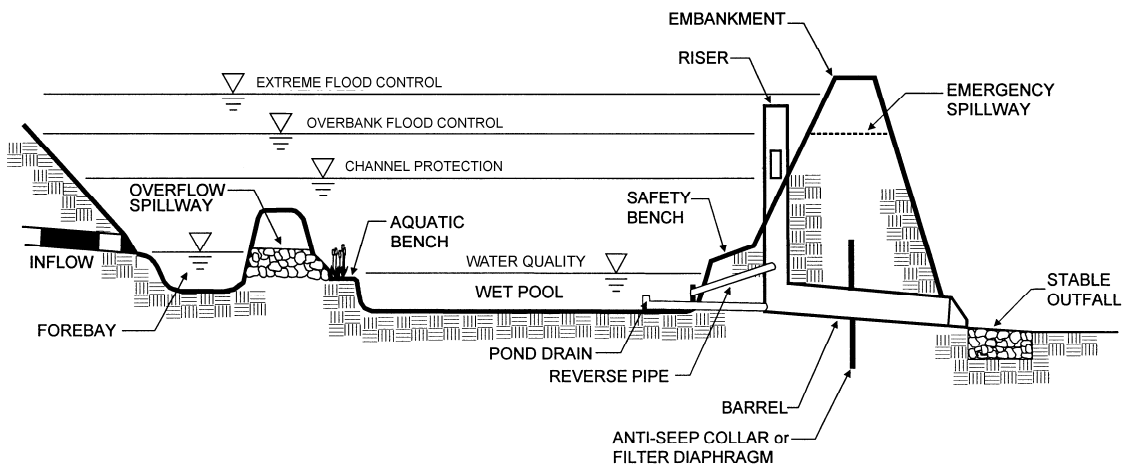

Figure 2.1 Example of Micropool Extended Detention Pond (P-1)



PLAN VIEW



PROFILE

Figure 2.2 Example of Wet Pond (P-2)

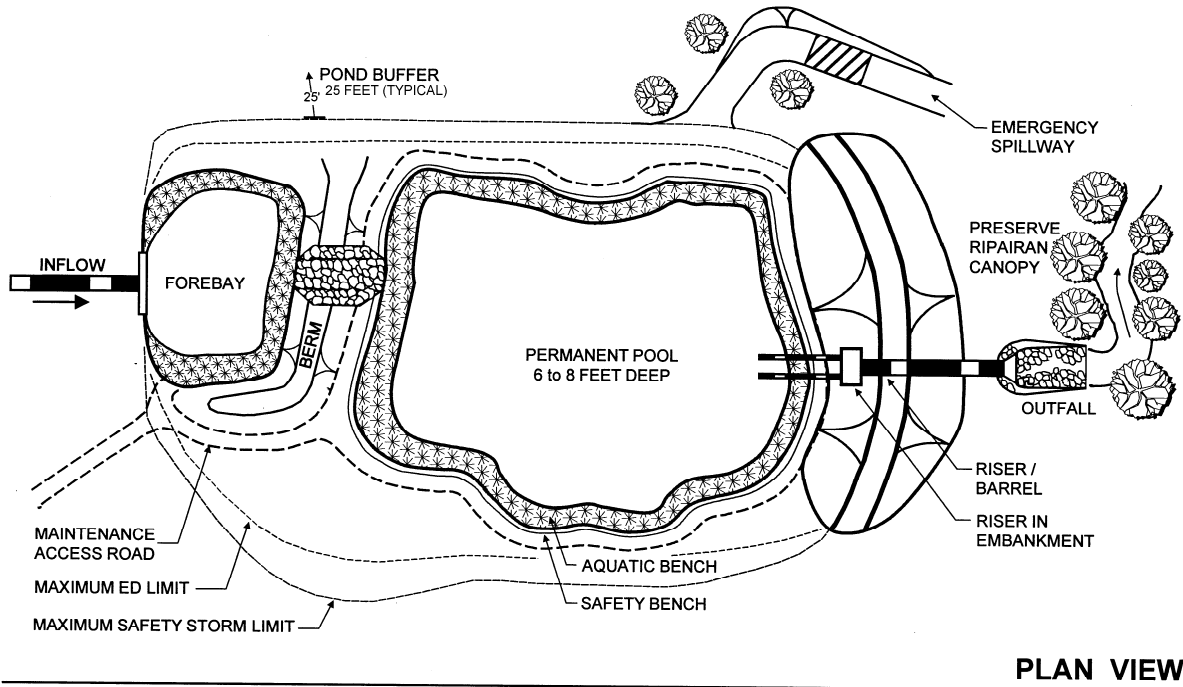

PLAN VIEW

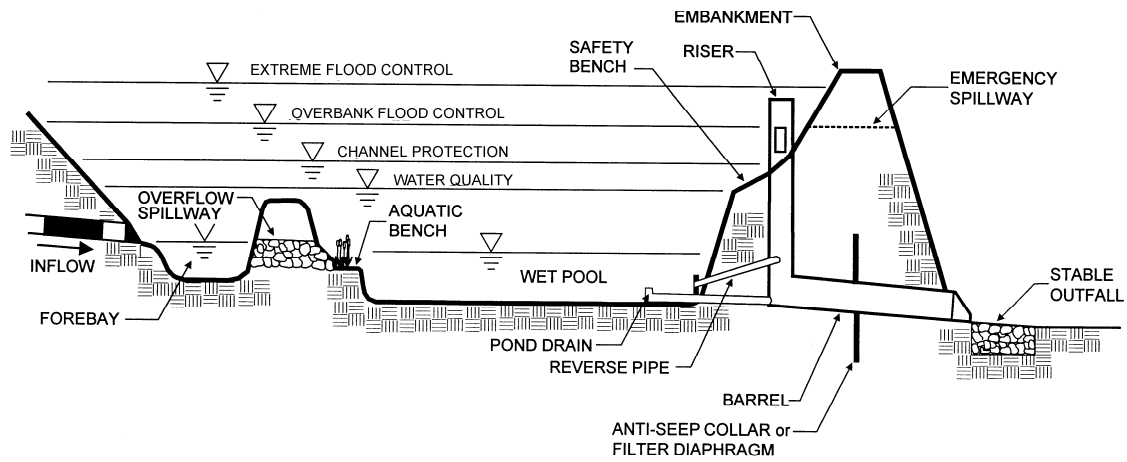

PROFILE

Figure 2.3 Example of Wet Extended Detention Pond (P-3)

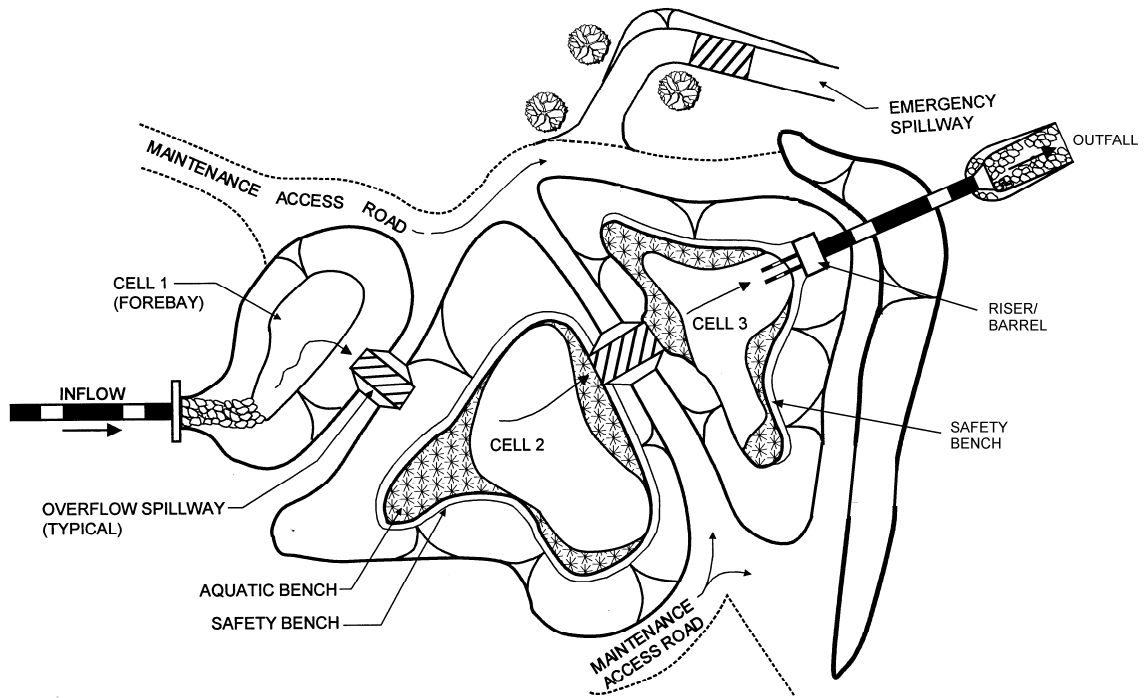

PLAN VIEW

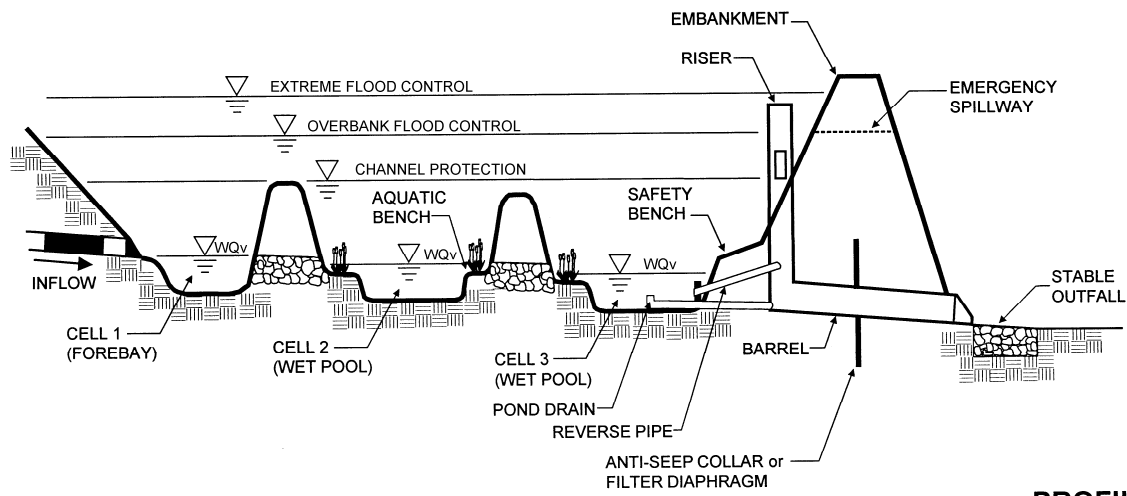

PROFILE

Figure 2.4 Example of Multiple Pond System (P-4)

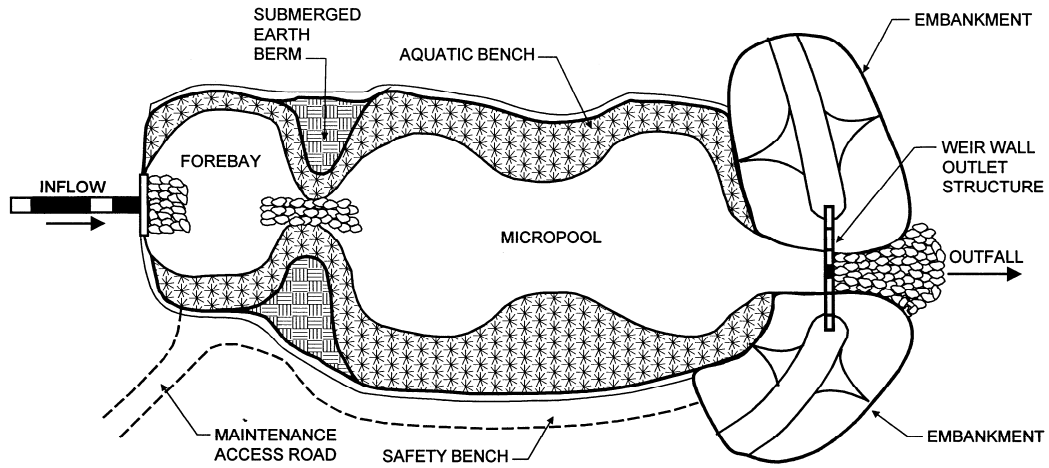

PLAN VIEW

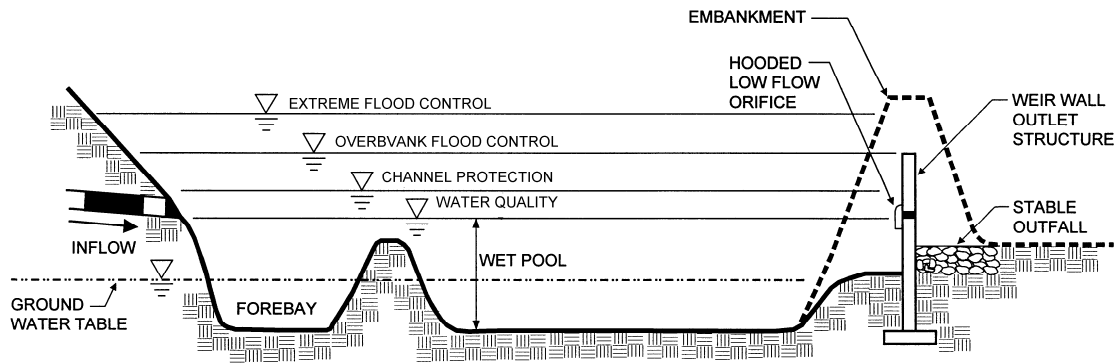

PROFILE

Figure 2.5 Example of Pocket Pond (P-5)

2.7.1.A. Pond Feasibility

Required Elements

- A site evaluation is necessary to establish the Hazard Classification. The designer should determine what design elements are required to ensure dam safety (See *dam standards and specifications in Appendix B1 of the Vermont Stormwater Management Manual, Volume II-Technical Guidance for guidance or other comparable guidance*).
- Determine depth to bedrock and soil properties using appropriate geotechnical investigations.

Design Guidance

- Stormwater ponds should not generally be located within jurisdictional waters, including wetlands. Exceptions might include severely degraded waters or to retrofit existing uncontrolled stormwater.
- Designs P-2, P-3, and P-4 should have a minimum contributing drainage area of 25 acres. A 10-acre drainage is recommended for design P-1.
- The use of stormwater ponds (with the exception of design P-1, Micropool Extended Detention Pond) on cold-water fish waters may have limited applicability, as available evidence suggests that these practices can increase stream temperatures. Under such circumstances, a site-specific assessment by the Agency is warranted to determine whether the treatment benefits of a wet pond outweigh the potential thermal impacts associated with the practice.
- Avoid location of pond designs within the stream channel, to prevent habitat degradation caused by these structures.

2.7.1.B. Pond Conveyance

Inlet Protection

Required Elements

- A forebay shall be provided at each inlet, unless the inlet provides less than 10% of the total design storm inflow to the pond (see Section 2.7.1.C for sizing criteria).

Design Guidance

- Inlet areas should be stabilized to ensure that non-erosive conditions exist during events up to the overbank flood event (i.e., Q_{p10}) (see Appendix D7 of the Vermont Stormwater Management Manual, Volume II-Technical Guidance for guidance on critical erosive velocities for grass and soil).
- Inlet pipe inverts should generally be located at or slightly below the permanent pool. If the inlet is partially submerged, in no case should it be submerged more than one half of the pipe diameter.

Adequate Outfall Protection

Required Elements

- The channel immediately below a pond outfall shall be modified to prevent erosion and conform to natural dimensions in the shortest possible distance, typically by use of appropriately sized riprap placed over filter cloth.

- A stilling basin or outlet protection shall be used to reduce flow velocities from the principal spillway to non-erosive velocities (3.5 to 5.0 fps). See Appendix D7 of the Vermont Stormwater Management Manual, Volume II-Technical Guidance for critical non-erosive velocities for grass and soils.

Design Guidance

- Outfalls should be constructed such that they do not increase erosion or have undue influence on the downstream morphology of the stream.
- Flared pipe sections that discharge at or near the stream invert or into a step-pool arrangement are preferred over headwalls at the spillway outlet.
- If a pond daylights to a channel with dry weather flow, care should be taken to minimize tree clearing along the downstream channel, and to reestablish a forested riparian zone in the shortest possible distance. Excessive use of riprap should be avoided to minimize stream warming.

Pond Liners

Design Guidance

- When a pond is located in gravelly sands or fractured bedrock, a liner may be needed to sustain a permanent pool of water. If geotechnical tests confirm the need for a liner, acceptable options include: (a) six to 12 inches of clay soil (minimum 15% passing the #200 sieve and a minimum permeability of 1×10^{-5} cm/sec), (b) a 30 ml poly-liner (c) bentonite, (d) use of chemical additives (see NRCS Engineering Field Manual, 1984), or (e) engineering design as approved on a case-by-case basis by the Agency.

2.7.1.C. Pond Pretreatment

Pre-treatment of roof runoff is not required, provided the runoff is routed to the treatment practice in a manner such that it is unlikely to accumulate significant additional sediment (e.g. via closed pipe system, or grass channel), and provided the runoff is not commingled with other runoff.

Sediment Forebay

Required Elements

- A sediment forebay is important for maintenance and longevity of a stormwater treatment pond. Each pond shall have a sediment forebay or equivalent upstream pretreatment. The forebay shall consist of a separate cell, formed by an acceptable barrier. Typical examples include earthen berms, concrete weirs, and gabion baskets.
- The forebay shall be sized to contain 10% of the water quality volume (WQ_v), and shall be four to six feet deep. The forebay storage volume counts toward the total WQ_v requirement.
- The forebay shall be designed with non-erosive outlet conditions (see Appendix D7 of the Vermont Stormwater Management Manual, Volume II-Technical Guidance).
- Direct access for appropriate maintenance equipment shall be provided to the forebay.

Design Guidance

- The forebay should be designed with a surface area equivalent to 10% of the pond permanent pool surface area or equivalent to 0.1% of the drainage area.

- A fixed vertical sediment depth marker should be installed in the forebay to measure sediment deposition over time.
- The bottom of the forebay may be hardened (i.e., concrete, asphalt, grouted riprap) to make sediment removal easier.

2.7.1.D. Pond Treatment

Minimum Water Quality Volume (WQ_v)

Required Elements

- Provide water quality treatment storage to capture the computed WQ_v from the contributing drainage area through a combination of permanent pool and extended detention. Storage in permanent pool and extended detention is outlined in Table 2.4.

Table 2.4 Water Quality Volume Distribution in Pond Designs

| Design Variation | WQ _v % | |
|--------------------------|-------------------|--------------------|
| | Permanent Pool | Extended Detention |
| P-1 Micropool ED Pond | 20% min. | 80% max. |
| P-2 Wet Pond | 100% | 0% |
| P-3 Wet ED Pond | 50% min. | 50% max. |
| P-4 Multiple Pond System | 50% min. | 50% max. |
| P-5 "Pocket" Pond | 50% min. | 50% max. |

- If extended detention is provided for water quality treatment in a pond, storage for CP_v and WQ_v shall be computed and routed separately (i.e., the WQ_v cannot be met simply by providing CP_v storage for the one year storm). **The extended detention water quality volume shall be released over a 24-hour period.**

Design Guidance

- It is generally desirable to provide water quality treatment off-line when topography, head and space permit.
- Approximately 15% of the permanent pool surface area should be allocated to a shallow (i.e., less than or equal to 6" in depth) zone along the perimeter to promote a shallow marsh littoral zone.
- Water quality storage can be provided in multiple cells. Performance is enhanced when multiple treatment pathways are provided by using multiple cells, longer flowpaths, high surface area to volume ratios, complex microtopography, and/or redundant treatment methods (combinations of pool, ED, and marsh).

Minimum Pond Geometry

Required Elements

- The minimum length to width ratio for ponds shall be 1.5:1 (i.e., length relative to width).
- Provide a maximum Drainage Area: Surface Area Ratio of 100:1 (applies to all design variants except P-1)

Design Guidance

- To the greatest extent possible, maintain a long flow path through the system, and design ponds with irregular shapes.

2.7.1.E. Pond Landscaping**Pond Benches**Required Elements

- The perimeter of all deep pool areas (four feet or greater in depth) shall be surrounded by two benches:
 1. Safety Bench: Except when pond side slopes are 4:1 (h:v) or flatter, provide a safety bench that generally extends 15 feet outward from the normal water edge to the toe of the pond side slope. The maximum slope of the safety bench shall be 6% (10' to 12' allowable on sites with extreme space limitations), however, if the pond is fenced, the safety bench can be reduced to 6 feet; *and*
 2. Aquatic Bench: Incorporate an aquatic bench that generally extends up to 15 feet inward from the normal shoreline, has an irregular configuration, and a maximum depth of eighteen inches below the normal pool water surface elevation.

Landscaping PlanRequired Elements

- A landscaping plan for a stormwater pond and its buffer shall be prepared to indicate how aquatic and terrestrial areas will be stabilized and established with vegetation (see Appendix A of the Vermont Stormwater Management Manual, Volume II-Technical Guidance for detailed guidance).
- Woody vegetation may not be planted or allowed to grow within 15 feet of the toe of the embankment and 25 feet from the principal spillway structure.

Design Guidance

- Wherever possible, wetland plants should be encouraged in a pond design, either along the aquatic bench (fringe wetlands), the safety bench and side slopes (ED wetlands) or within shallow areas of the pool itself.
- The best elevations for establishing wetland plants, either through transplantation or volunteer colonization, are within six inches (plus or minus) of the normal pool.
- The soils of a pond buffer are often severely compacted during the construction process to ensure stability. The density of these compacted soils can be so great that it effectively prevents root penetration, and therefore, may lead to premature mortality or loss of vigor of vegetation. Consequently, it is advisable to excavate large and deep holes around the proposed planting sites, and backfill these with uncompacted topsoil.
- As a rule of thumb, planting holes should be three times deeper and wider than the diameter of the rootball (of balled and burlap stock), and five times deeper and wider for container grown stock. This practice should enable the stock to develop unconfined root systems. Avoid species that require full shade, are susceptible to winterkill, or are prone to wind damage. Extra mulching around the base of the tree or shrub is strongly recommended as a means of conserving moisture and suppressing weeds.

Pond Buffers and Setbacks

Design Guidance

- A pond buffer should be provided that extends 25 feet outward from the maximum water surface elevation of the pond. Permanent structures (e.g., buildings) should not be constructed within the buffer.
- The pond buffer should be contiguous with other buffer areas that are required by existing regulations (e.g., stream buffers).
- Existing trees should be preserved in the buffer area during construction. It is desirable to locate forest conservation areas adjacent to ponds. To help discourage resident geese populations, the buffer can be planted with trees, shrubs and native ground covers.
- Annual mowing of the pond buffer is only required along maintenance rights-of-way and the embankment. The remaining buffer can be managed as a meadow (mowing every other year) or forest.

2.7.1.F. Pond Maintenance

Required Elements

- Maintenance responsibility for a pond and its buffer shall be vested with a responsible authority by means of a legally binding and enforceable maintenance agreement that is executed as a condition of plan approval.
- The principal spillway shall be equipped with a removable trash rack, and generally accessible from dry land.

Design Guidance

- Sediment removal in the forebay should occur every 5 to 6 years or after 50% of total forebay capacity has been lost.
- Sediments excavated from stormwater ponds that do not receive runoff from designated hotspots are generally not considered toxic or hazardous material, and can be safely disposed by either land application or land filling. Sediment testing may be required prior to sediment disposal when a hotspot land use is present (see Table 2.3 for a list of potential hotspots).
- Sediment removed from stormwater ponds should be disposed of according to an approved comprehensive operation and maintenance plan.
- More detailed maintenance guidance and pond operation and maintenance checklists are provided in Appendix D8 of the Vermont Stormwater Management Manual, Volume II-Technical Guidance.

Maintenance Access

Required Elements

- A maintenance right of way or easement shall extend to a pond from a public or private road.

Design Guidance

- Maintenance access should be at least 12 feet wide, have a maximum slope of no more than 15%, and be appropriately stabilized to withstand maintenance equipment and vehicles. Steeper grades are allowable with stabilization techniques such as a gravel road.
- The maintenance access should extend to the forebay, safety bench, riser, and outlet and be designed to allow vehicles to turn around.

Non-clogging Low Flow Orifice

Required Elements

- A low flow orifice shall be provided, with the size or design for the orifice sufficient to ensure that no clogging shall occur.

Design Guidance

- The low flow orifice should be adequately protected from clogging by either an acceptable external trash rack (recommended minimum orifice of 3") or by internal orifice protection that may allow for smaller diameters (recommended minimum orifice of 1"). Appendix D5 of the Vermont Stormwater Management Manual, Volume II-Technical Guidance contains design details for both low flow orifice protection options.
- The preferred method is a submerged reverse-slope pipe that extends downward from the riser to an inflow point one foot below the normal pool elevation (see Appendix D5 of the Vermont Stormwater Management Manual, Volume II-Technical Guidance for a typical detail).
- Alternative methods are to employ a broad crested rectangular, V-notch, or proportional weir, protected by a half-round CMP that extends at least 12 inches below the normal pool.
- The use of horizontally extended perforated pipe protected by geotextile fabric and gravel is not recommended. Vertical pipes may be used as an alternative if a permanent pool is present.

Riser in Embankment

Design Guidance

- The riser should be located within the embankment for maintenance access, safety and aesthetics. In addition, the riser should be located so that short-circuiting between inflow points and the riser does not occur.
- Access to the riser should be provided by lockable manhole covers, and manhole steps within easy reach of valves and other controls. The principal spillway opening should be "fenced" with pipe or rebar at 8 inch intervals (for safety purposes).

Pond Drain

Design Guidance

- Except where local slopes prohibit this design, each pond should have a drain pipe that can completely or partially drain the pond. The drain pipe should have an elbow or protected intake within the pond to prevent sediment deposition, and a diameter capable of draining the pond within 24 hours.
- Care should be exercised during pond drawdowns to prevent rapid drawdown and minimize downstream discharge of sediments or anoxic water. The approving jurisdiction should be notified before draining a pond.

Adjustable Gate Valve

Design Guidance

- Both the WQ_v release pipe and the pond drain should be equipped with an adjustable gate valve (typically a handwheel activated knife gate valve).
- Valves should be located inside of the riser at a point where they: (a) will not normally be inundated and (b) can be operated in a safe manner.

- Both the WQ_v release pipe and the pond drain should be sized one pipe size greater than the calculated design diameter.
- To prevent vandalism, the handwheel should be chained to a ringbolt, manhole step or other fixed object.

Safety Features

Required Elements

- Side slopes to the pond shall not exceed 3:1 (h:v), and shall terminate on a safety bench.
- The principal spillway opening shall not permit access by small children, and endwalls above pipe outfalls greater than 48 inches in diameter shall be fenced to prevent a hazard.

Design Guidance

- Both the safety bench and the aquatic bench may be landscaped to prevent access to the pool.
- Warning signs prohibiting swimming and skating may be posted.
- Pond fencing is generally not encouraged, but may be required in some situations, or by some municipalities. A preferred method is to manage the contours of the pond to eliminate drop-offs or other safety hazards.

2.7.1.G. Cold Climate Pond Design Considerations

The following section provides design guidance for possible modifications to ponds to reflect the severe winter climate in Vermont. This design guidance is **not mandatory**, with the exception of “Pipe Freezing and Clogging” and “Road Sand Build-Up”, but site designers may consider these modifications on a case-by-case basis as a function of site conditions, receiving water sensitivity, or downstream flooding threat.

Inlets, outlet structures and outfall protection for pond systems require modifications to function well in cold climates. Potential conditions and problems to be aware of with stormwater ponds in cold climates include:

- Higher runoff volumes and increased pollutant loads during the spring melt
- Pipe freezing and clogging
- Ice formation on the permanent pool
- Road sand build-up
- Snow storage

Higher Runoff Volumes and Increased Pollutant Loads During the Spring Melt

- Consider a seasonal operational approach of the pond based on seasonal inputs and by adjusting dual water quality outlets to provide additional storage (see Figure 2.6).
- Consider sizing adaptations based on snowmelt characteristics and receiving water sensitivity.
- Do not drain ponds during the spring season. Due to temperature stratification and high chloride concentrations at the bottom, the water may become highly acidic and anoxic and may cause negative downstream effects.

Pipe Freezing and Clogging

- Inlet pipes should not be submerged, since this can result in freezing and upstream damage or flooding.

- Burying all pipes below the frost line can prevent frost heave and pipe freezing.
- Increase the slope of inlet pipes to a minimum of 1% to prevent standing water in the pipe, reducing the potential for ice formation. This design may be difficult to achieve at sites with flat local slopes.
- If perforated riser pipes are used, the minimum opening diameter should be $\frac{1}{2}$ ". In addition, the pipe should have a minimum 6" diameter.
- When a standard weir is used, the minimum slot width should be 3", especially when the slot is tall.
- Baffle weirs (essentially fences in the pond) can prevent ice reformation during the spring melt near the outlet by preventing surface ice from blocking the outlet structure.
- In cold climates, riser hoods should be oversized and reverse slope pipes should draw from at least 6" below the typical ice layer.
- Trash racks should be installed at a shallow angle to prevent ice formation (See Appendix D5 of the Vermont Stormwater Management Manual, Volume II-Technical Guidance).

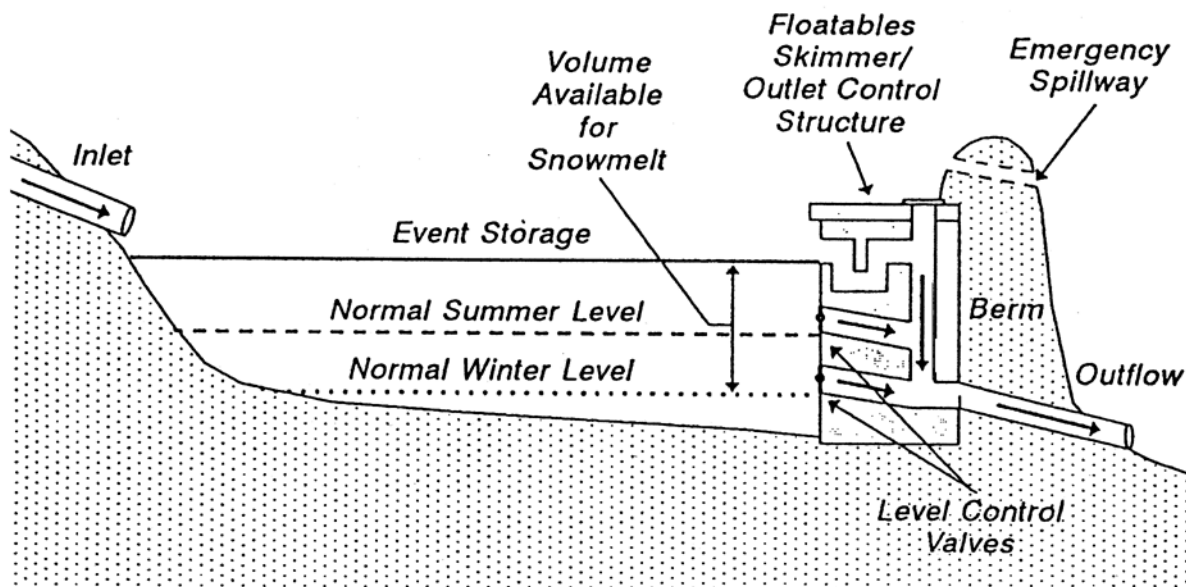

Figure 2.6 Seasonal Operation Pond (Source: Oberts, 1994)

Ice Formation on the Permanent Pool

- In cold climates, the treatment volume of a pond system may be adjusted to account for ice build-up on the permanent pool by providing twelve inches of additional storage to compensate for the build-up of ice on the surface. The additional storage should be provided by increasing the surface area of the pond, while maintaining a recommended maximum depth of eight feet.
- Using pumps or bubbling systems can reduce ice build-up and prevent the formation of an anaerobic zone in pond bottoms.
- Provide some storage as extended detention. This recommendation is made for very cold climates to provide detention while the permanent pond is iced over. In effect, it discourages the use of wet ponds (P-2), replacing them with wet extended detention ponds (P-3).
- Multiple pond systems are recommended regardless of climate because they provide redundant treatment options. In cold climates, a berm or simple weir should be used instead of pipes to separate multiple ponds, due to their higher freezing potential.

Road Sand Build-up

- In areas where road sand is used, an inspection of the forebay and pond should be scheduled after the spring melt to determine if dredging is necessary. For forebays, dredging is needed if one half of the capacity of the forebay is full.

2.7.2 Stormwater Wetlands

Stormwater wetlands are practices that create shallow marsh areas to treat stormwater and often incorporate small permanent pools and/or extended detention storage to achieve the full WQ_v . Design variants include:

| | | |
|-----|---------------------|---------------|
| W-1 | Shallow Wetland | (Figure 2.7) |
| W-2 | ED Shallow Wetland | (Figure 2.8) |
| W-3 | Pond/Wetland System | (Figure 2.9) |
| W-4 | Gravel Wetland | (Figure 2.10) |

Treatment Suitability: Stormwater wetland designs W-1 through W-3 can be used to provide Channel Protection volume as well as Overbank and Extreme Flood attenuation. Design variant W-4 is generally used to provide only water quality treatment. In W-1 – W-3, the permanent pool is stored in a depression excavated into the ground surface. Wetland plants are planted at the wetland bottom, particularly in the shallow regions. In W-4, a permanent pool is contained within a gravel media and wetland plants are rooted directly in the gravel media.

Potential cold climate design modifications that address the primary concerns associated with wetlands in cold climates are provided at the end of this section. **The cold climate design modifications are presented as guidance only and are not required elements.** A more detailed discussion of cold climate modifications can be found in the publication *Stormwater BMP Design Supplement for Cold Climates* (Caraco & Claytor, 1997).

NOTES:

- Unless specified herein, all of the pond criteria presented in stormwater ponds (section 2.7.1) also apply to the design of stormwater wetlands including: conveyance criteria, forebay depths and surface area, ponding depths for permanent pools, benches, etc. Additional criteria that govern the geometry and establishment of created wetlands are presented in this section.
- Any practice that creates an embankment (i.e., a barrier to confine or raise water for storage or diversion) should follow the guidance presented in the dam standards and specifications (Appendix B1 of the Vermont Stormwater Management Manual, Volume II-Technical Guidance) or comparable design specifications, and may require a permit from the Dam Safety Section of the Agency.

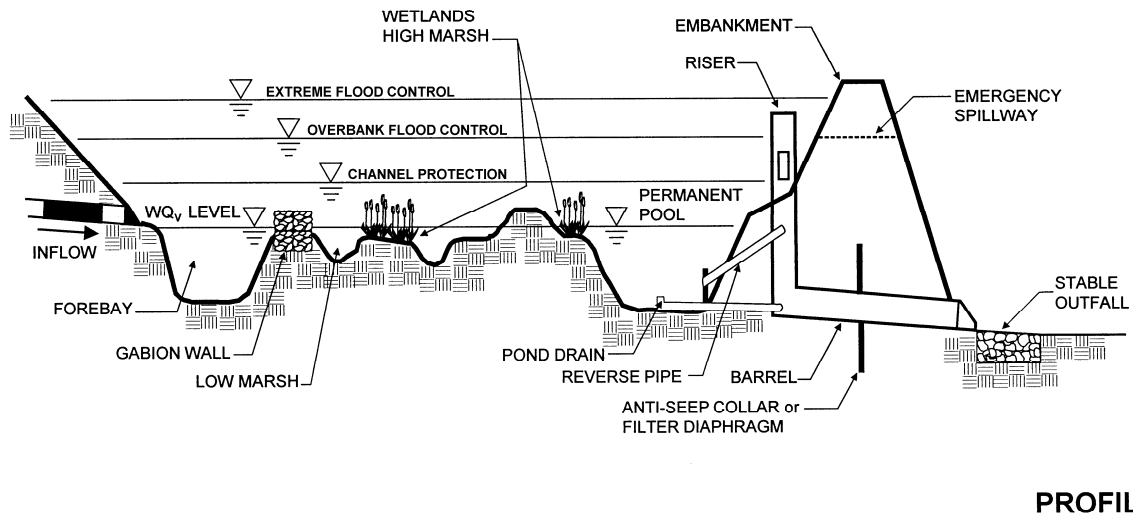
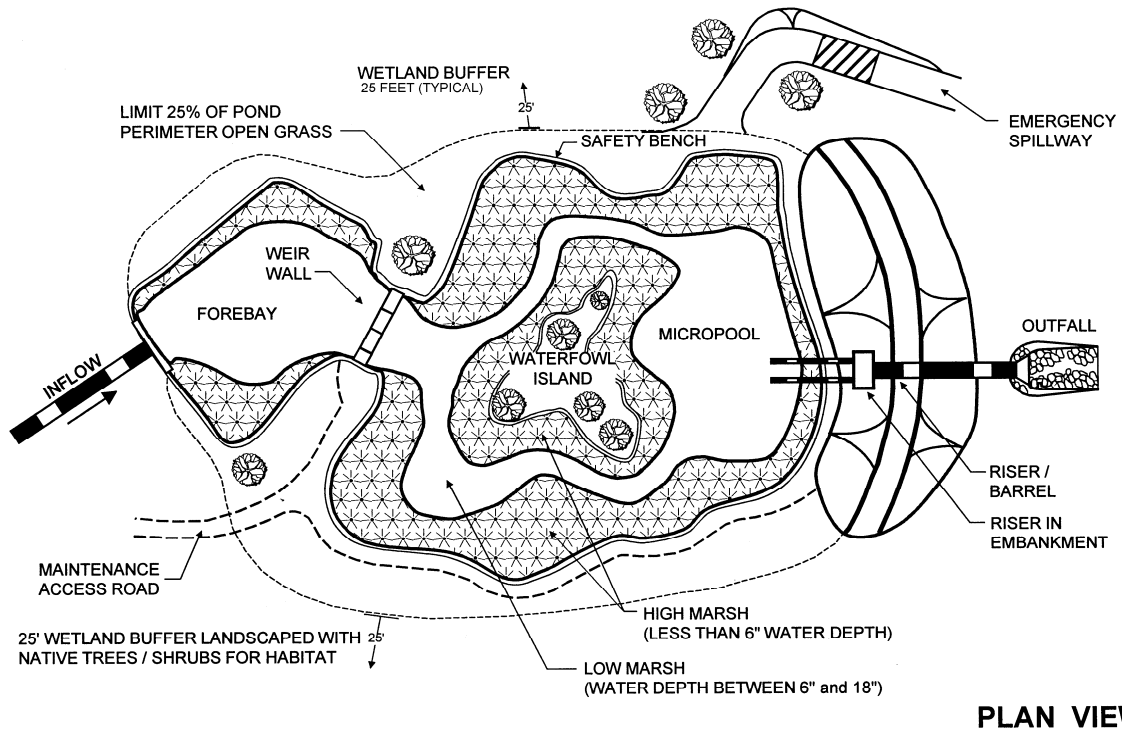
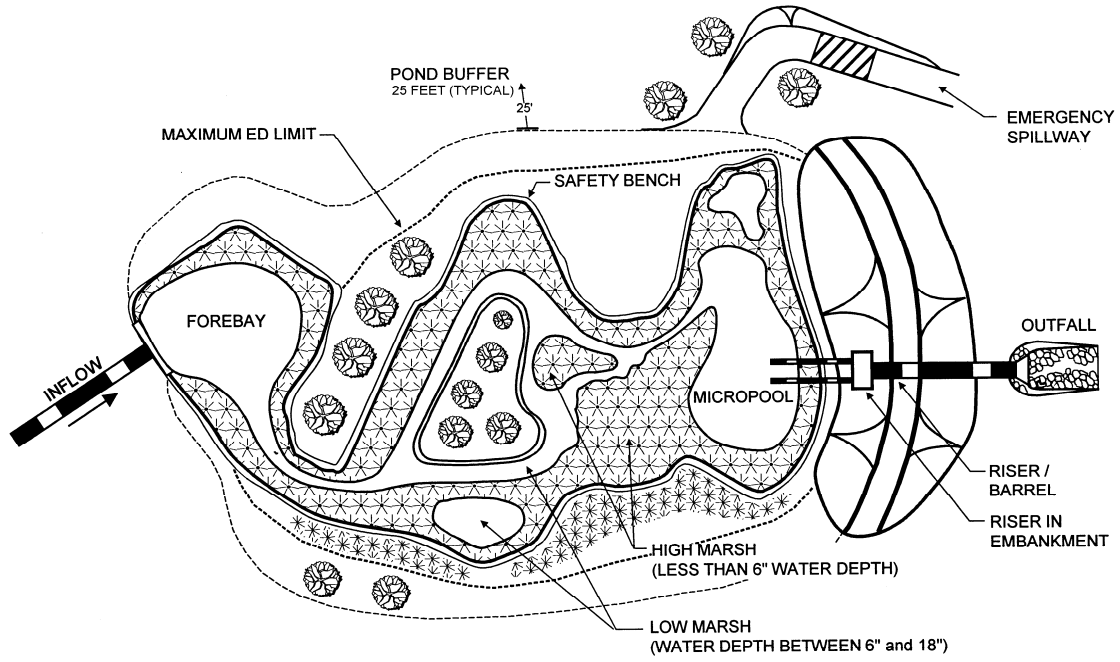
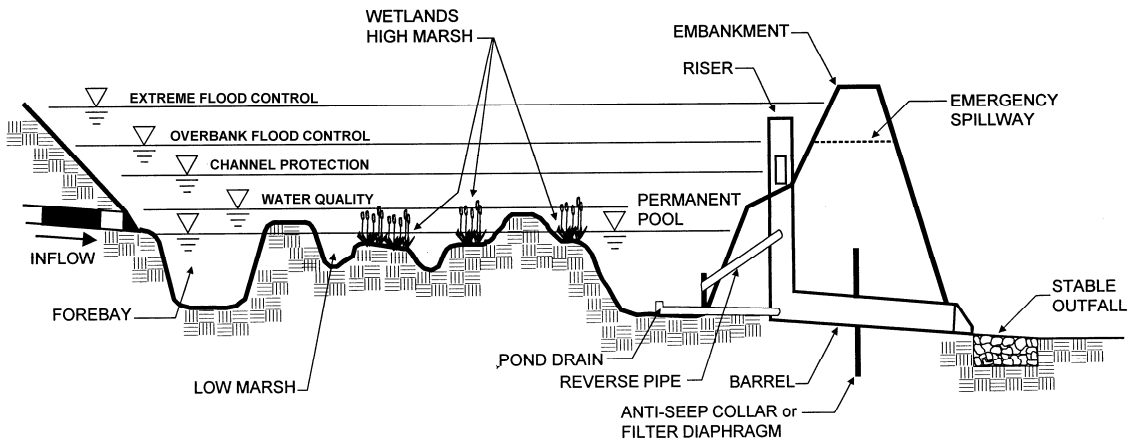

Figure 2.7 Example of Shallow Wetland (W-1)



PLAN VIEW



PROFILE

Figure 2.8 Example of Extended Detention Shallow Wetland (W-2)

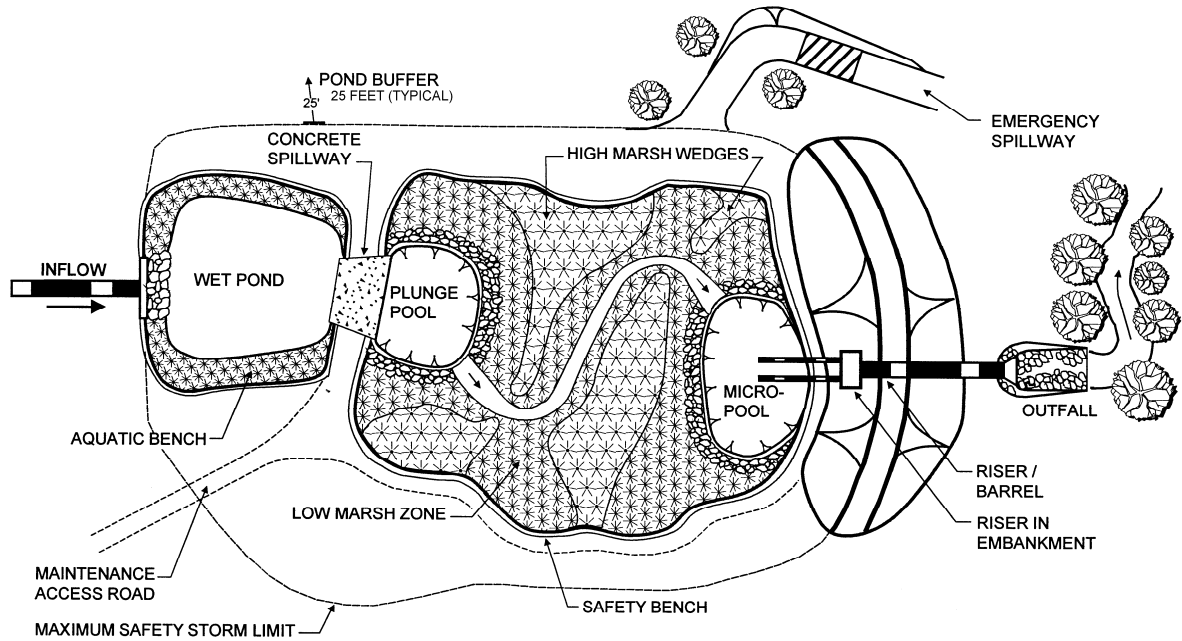

PLAN VIEW

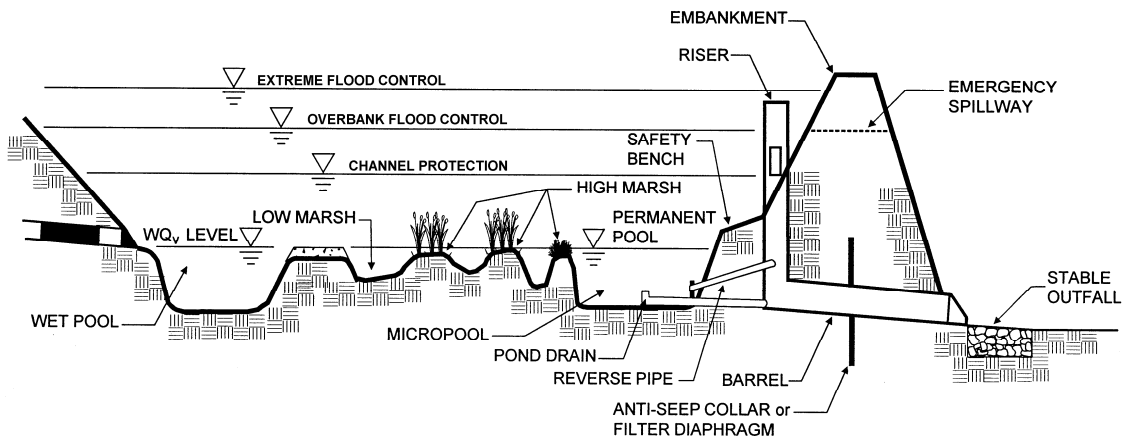

PROFILE

Figure 2.9 Example of Pond/Wetland System (W-3)

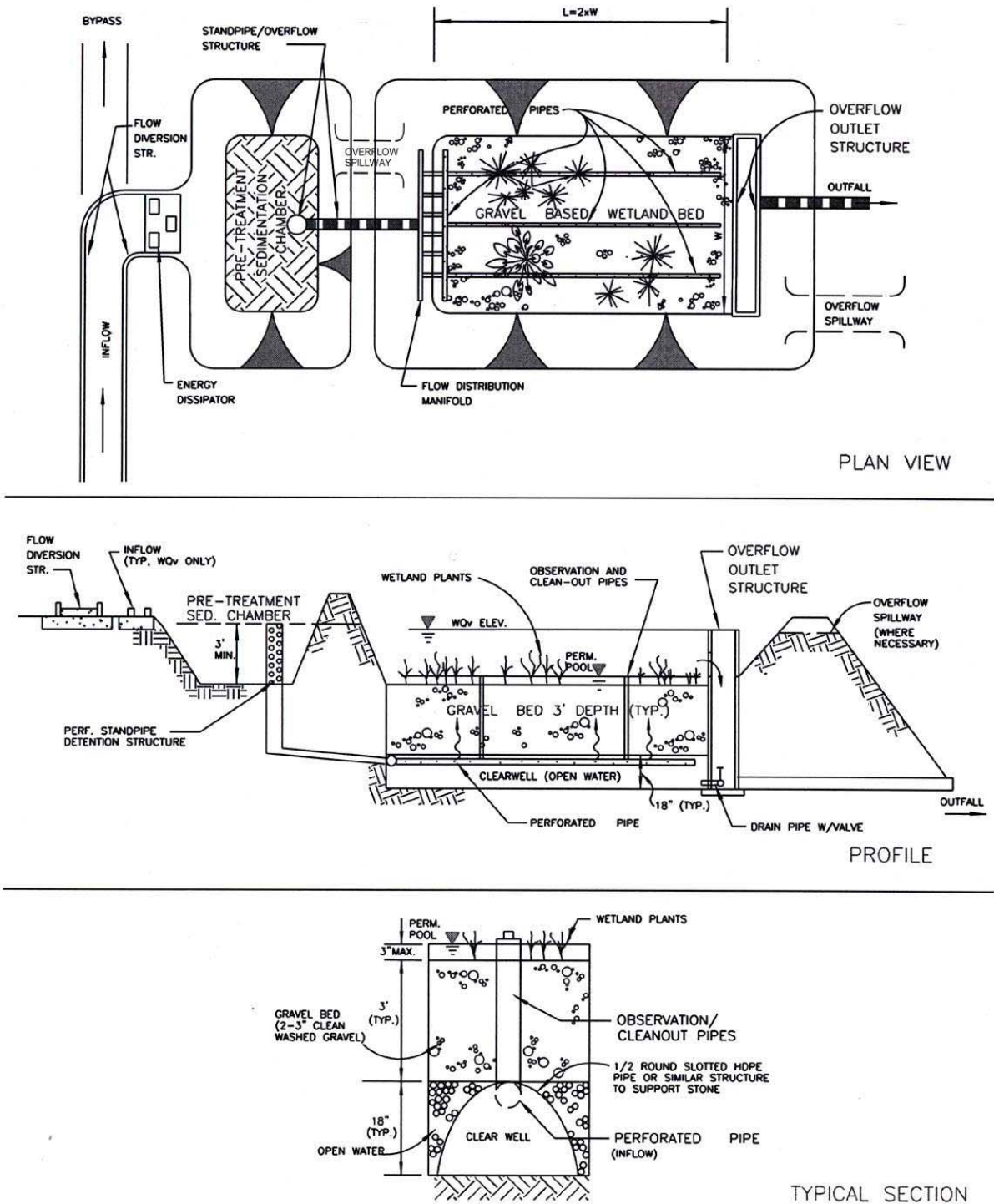

Figure 2.10 Example of Gravel Wetland (W-4)

2.7.2.A. Wetland Feasibility

Design Guidance

- Stormwater wetlands should not be located within existing jurisdictional wetlands. In some isolated cases, a permit may be granted to convert an existing degraded wetland in the context of local watershed restoration efforts.
- The use of stormwater wetlands on cold-water fish habitat waters may have limited applicability, as available evidence suggests that these practices can increase stream temperatures. Under such circumstances, a site-specific assessment by the Agency is warranted to determine whether the treatment benefits of a stormwater wetland outweigh the potential thermal impacts associated with the practice.

2.7.2.B. Wetland Conveyance

Required Elements

- Flowpaths from the inflow points to the outflow points of stormwater wetlands shall be maximized.
- A minimum flowpath of 2:1 (length to relative width) shall be provided across the stormwater wetland. This path may be achieved by constructing internal berms (e.g., high marsh wedges or rock filter cells).

Design Guidance

- Microtopography is encouraged to enhance wetland diversity.

2.7.2.C. Wetland Pretreatment

Pre-treatment of roof runoff is not required, provided the runoff is routed to the treatment practice in a manner such that it is unlikely to accumulate significant additional sediment (e.g. via closed pipe system, or grass channel), and provided the runoff is not commingled with other runoff.

Required Elements

- For design variants W-1 – W-3, a forebay shall be located at the inlet with a volume equal to 10% of the WQ_v , and a four to six foot deep micropool that also stores approximately 10% of the WQ_v shall be located at the outlet to protect the low flow pipe from clogging and prevent sediment resuspension.
- For design variant W-4, a forebay shall be located at the inlet and contain a volume equal to 25% of the WQ_v .

2.7.2.D. Wetland Treatment

Provide water quality treatment storage to capture the computed WQ_v from the contributing drainage area through a combination of permanent pool and extended detention. Storage and surface area guidance for the four-stormwater wetland design variants are listed in Table 2.5.

Required Elements for Design Variants W-1 – W-3

- The surface area of the entire stormwater wetland shall be at least one percent of the contributing drainage area (1.5% for the shallow wetland design, W-1).

- At least 25% of the WQ_v of a stormwater wetland shall be in deepwater zones with a depth greater than four feet.
- A minimum of 35% of the total surface area of stormwater wetlands shall have a depth of six inches or less, and at least 65% of the total surface area shall be shallower than 18 inches.
- If extended detention is used in a stormwater wetland, the WQ_v volume shall comprise no more than 50% of the total WQ_v , and its maximum water surface elevation shall not extend more than three feet above the permanent pool. In addition, storage for CP_v and WQ_v shall be computed and routed separately (i.e., the WQ_v cannot be met simply by providing CP_v storage for the one year storm). The extended detention water quality volume shall be released over a 24-hour period.

Required Elements for Design Variant W-4

- The surface area of the gravel bed shall be at least 0.25% of the contributing drainage area, assuming a 3' deep gravel bed. For design depths other than 3', use the following relationship:

$$SA = (3/d) \times 0.0025 \times A$$

Where:

| | | |
|----|---|--------------------------|
| SA | = | surface area (in acres) |
| d | = | design depth (in feet) |
| A | = | drainage area (in acres) |

- The gravel bed surface shall have a length to width ratio of 2:1.
- The entire facility shall be sized to temporarily detain 100% of the WQ_v (either as 12- or 24-hour extended detention, depending on the receiving water classification).

Design Guidance

Table 2.5 provides guidance for water quality and surface area distribution in stormwater wetlands.

Table 2.5 Water Quality Volume and Surface Area Distribution in Stormwater Wetland Design Variants (Design Guidance)

| Design Variant | % Of WQ _v | | | | | | Minimum Surface Area Allocation | | | | |
|-------------------------|--|------------------|------|-------|------------|----------------------|---------------------------------|--------------------------|----------|-----------|--------------------------|
| | Minimum Permanent Pool Volume Allocation | | | | | Allow-able ED Volume | | | | | |
| | Forebay ¹ | Deep Pool (≥ 4') | ≤ 6" | ≤ 18" | Gravel Bed | | % of DA | Deep Pool (≥ 4') | ≤ 6" | 6" to 18" | Gravel Bed |
| W-1 Shallow Wetland | 10% | 25% | 10% | 65% | - | 0 | 1.5% of DA ² | 25% | Min. 35% | 30% | - |
| W-2 ED Shallow Wetland | 10% | 25% | 5% | 25% | - | 50% | 1.0% of DA | 20% | Min. 35% | 45% | - |
| W-3 Pond/Wetland System | 10% | 70% | 5% | 30% | - | 50% | 1.0% of DA | 35% | Min. 35% | 25% | - |
| W-4 Gravel Wetland | 25% | 25% | - | - | 5% | 70% | 0.35% of DA ³ | 28.6% of DA ⁴ | - | - | 71.4% of DA ⁴ |

¹ The forebay volume is inclusive within the deep water volume allocation.

² DA is the contributing drainage area.

³ The surface area includes a minimum forebay surface area equal to 0.10% of the DA.

⁴ Designers should provide a minimum surface area for the gravel bed equal to 0.25% of the DA with a minimum forebay surface equal to 0.1% of the DA, therefore the minimum deep water allocation is equal to $0.1/0.35 \times (100) = 28.6\%$, and the corresponding gravel bed area is $0.25/0.35 \times 100 = 71.4\%$.

- The bed of stormwater wetlands should be graded to create maximum internal flow path and microtopography.
- The W-4 design variant should be used where greater nitrogen removal is required. In this case, rock beds should be used as a medium for growth of wetland plants. The rock should be one to three inches in diameter, placed up to the normal pool elevation, and open to flow-through from a subsurface direction.

2.7.2.E. Wetland Landscaping

Required Elements

- A landscaping plan shall be provided that indicates the methods used to establish and maintain wetland coverage. Minimum elements of a plan include: delineation of pondscaping zones, selection of corresponding plant species, planting plan, sequence for preparing wetland bed (including soil amendments, if needed) and sources of plant material.

Design Guidance

- For stormwater wetlands, a wetland plant buffer should extend 25 feet outward from the maximum water surface elevation, with an additional 15-foot setback to structures.
- Donor soils for stormwater wetland mulch should not be removed from natural wetlands.
- Structures such as fascines, coconut rolls, straw bales, or carefully designed stone weirs can be used to create shallow marsh cells in high-energy areas of the stormwater wetland.
- The landscaping plan should provide elements that promote greater wildlife and waterfowl use within the stormwater wetland and buffers.
- Follow stormwater wetland establishment guidelines (See Appendix A of the Vermont Stormwater Management Manual, Volume II-Technical Guidance).

2.7.2.F. Wetland Maintenance

Required Elements

- If a minimum coverage of 50% is not achieved in the planted wetland zones after the second growing season, a reinforcement planting is required.

Design Guidance

- Stormwater wetlands that are separated from jurisdictional wetlands and regularly maintained are not regulated under State and Federal wetland laws.
- Wetland plant harvesting has shown little overall capability to enhance pollutant removal effectiveness (Shutes *et al.*, 1993); therefore, only in unusual or exceptional circumstances should plant harvesting be considered.
- Over time, the gravel-based system (W-4) will accumulate detritus within the voids of the gravel. For this reason, the system will require semi-annual flushing to ensure consistent hydraulic conductivity.

2.7.2.G. Cold Climate Design Considerations

The following section provides design guidance for possible modifications to wetlands to reflect the severe winter climate in Vermont. This design guidance is mandatory, but site designers may consider these modifications on a case-by-case basis as a function of site conditions, receiving water sensitivity, or downstream flooding threat.

Many of the cold climate concerns for stormwater wetlands are very similar to the ones for ponds. The short growing season and the use of salt (i.e., chlorides) on road surfaces are two additional concerns regarding potential impacts to stormwater wetlands and wetland plants.

Short Growing Season

- The planting schedule should reflect the short growing season. Site designers should consider incorporating relatively mature plants, or planting dormant rhizomes during the winter.

Chlorides

- Provide a grassed infiltration area prior to the stormwater wetland to provide some infiltration of chlorides to dampen the shock to wetland plants.
- Emphasize the pond/wetland design option to dilute chlorides prior to the wetland area. If this option is used, the pond should use the modifications described in Section 2.7.1.G. The pond system helps to dilute chlorides before they enter the stormwater wetland marsh, protecting wetland plants.
- Consider salt-tolerant plants if the stormwater wetland treats runoff from roads or parking lots that are treated with salt.

2.7.3 Stormwater Infiltration Practices

Stormwater infiltration practices capture and temporarily store the WQ_v before allowing it to infiltrate into the soil over a two-day period. Design variants include:

| | | |
|-----|---------------------|---------------|
| I-1 | Infiltration Trench | (Figure 2.11) |
| I-2 | Infiltration Basin | (Figure 2.12) |

Treatment Suitability: Infiltration practices typically cannot provide channel protection (CP_v) and overbank or extreme flood detention (Q_p) storage, except on sites where the soil infiltration rate is greater than 5.0 in/hr. Extraordinary care should be taken to assure that long-term infiltration rates are achieved through the use of performance bonds, post construction inspection and long-term maintenance.

Potential cold climate design modifications that address the primary concerns associated with infiltration practices in cold climates are provided at the end of this section. **The cold climate design modifications are presented as guidance only and are not required elements.** A more detailed discussion of cold climate modifications can be found in the publication *Stormwater BMP Design Supplement for Cold Climates* (Caraco & Claytor, 1997).

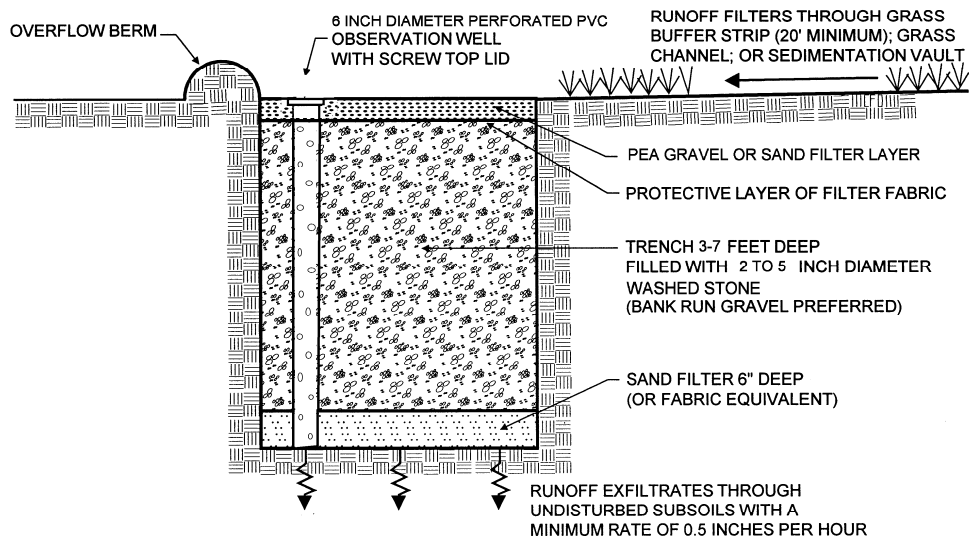
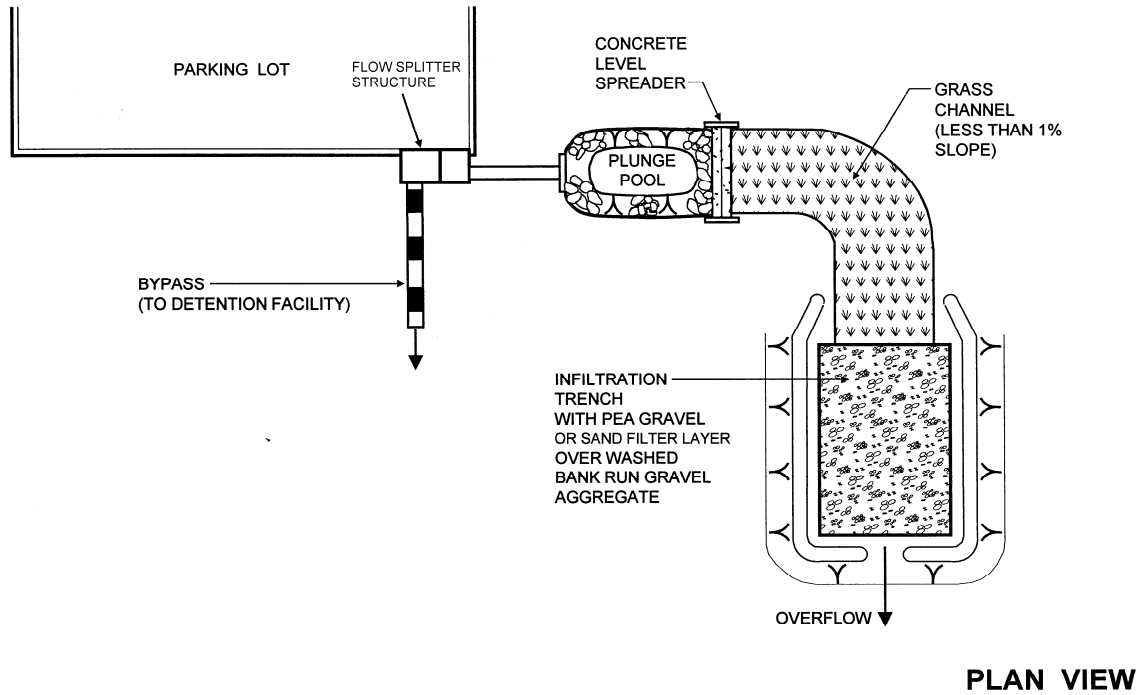
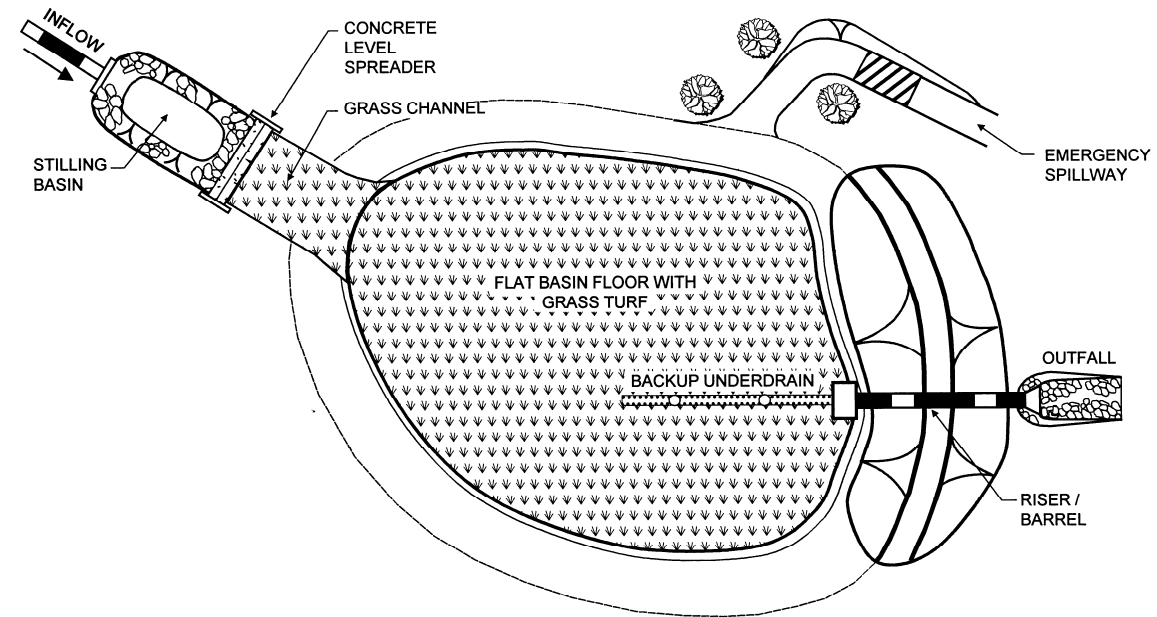
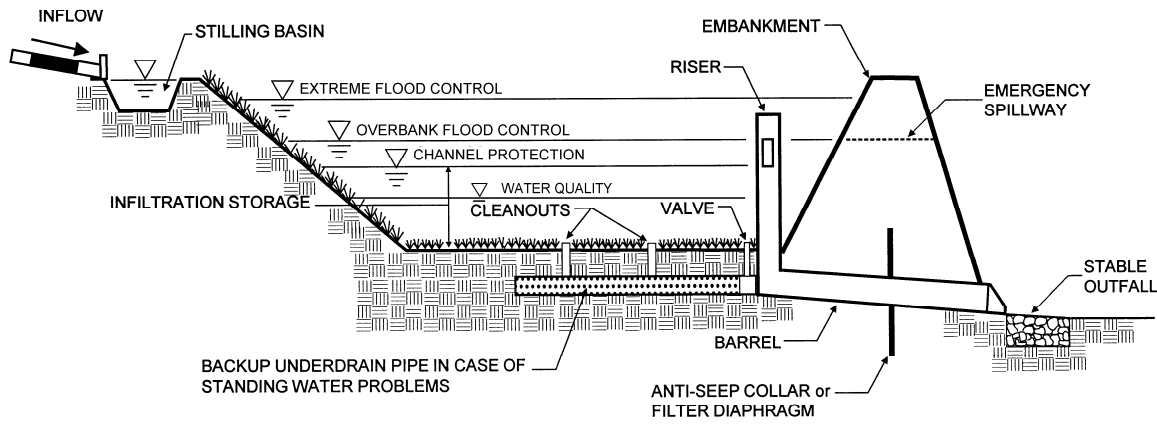

Figure 2.11 Example of Infiltration Trench (I-1)



PLAN VIEW



PROFILE

Figure 2.12 Example of Infiltration Basin (I-2)

2.7.3.A. Infiltration Feasibility

Required Elements

- To be suitable for infiltration, underlying soils shall have an infiltration rate (f_c) of at least 0.5 inches per hour, as initially determined from NRCS soil textural classification, and subsequently confirmed by field geotechnical tests (see Appendix D1 of the Vermont Stormwater Management Manual, Volume II-Technical Guidance).
- Soils shall also have a clay content of less than 20% and a silt/clay content of less than 40%.
- Infiltration practices cannot be located on areas with natural slopes greater than 15%.
- Infiltration practices cannot be located in fill soils, except for the top 25% of an infiltration trench.
- To protect groundwater from possible contamination, runoff from designated hotspot land uses or activities must not be directed to a formal infiltration facility.
- The bottom of the infiltration facility shall be separated by at least three feet vertically from the seasonally high water table or bedrock layer, as documented by on-site soil testing.
- Infiltration facilities shall be located at least 100 feet horizontally from any water supply well.

Design Guidance

- The maximum contributing area to infiltration basins or trenches should generally be less than 5 acres. The infiltration basin can theoretically receive runoff from larger areas, provided that the soil is highly permeable.
- Infiltration trenches and basins should be set back 35 feet from structures and septic systems.

2.7.3.B. Infiltration Conveyance

Required Elements

- The overland flow path of surface runoff exceeding the capacity of the infiltration system shall be evaluated to preclude erosive concentrated flow during the overbank events. If computed flow velocities exceed erosive velocities (see Appendix D7 of the Vermont Stormwater Management Manual, Volume II-Technical Guidance), an overflow channel shall be provided to a stabilized watercourse.
- All infiltration systems shall be designed to fully de-water the entire WQ_v within 48 hours after the storm event.
- If runoff is delivered by a storm drain pipe or along the main conveyance system, the infiltration practice must be designed as an off-line practice (See Appendix D5 of the Vermont Stormwater Management Manual, Volume II-Technical Guidance for a detail), except when used as a flood control practice.

Design Guidance

- For infiltration basins and trenches, adequate stormwater outfalls should be provided for the overflow associated with the 10-year design storm event (the design should provide for non-erosive velocities on the down-slope).

2.7.3.C. Infiltration Pretreatment

Required Pretreatment Techniques to Prevent Clogging

Pre-treatment of roof runoff is not required, provided the runoff is routed to the infiltration practice in a manner such that it is unlikely to accumulate significant additional sediment (e.g. via closed pipe system, or grass channel), and provided the runoff is not commingled with other runoff.

Required Elements

- For infiltration basins and trenches, a minimum pretreatment volume of at least 25% of the WQ_v must be provided prior to entry to an infiltration facility, and can be provided in the form of a sedimentation basin, sump pit, grass channel, filter strip, plunge pool or some combination of these measures.
- If the f_c for the underlying soils is greater than 2.0 inches per hour, a minimum pretreatment volume of at least 50% of the WQ_v must be provided.
- If the f_c for the underlying soils is greater than 5.0 inches per hour, 100% of the WQ_v shall be pre-treated prior to entry into an infiltration facility.
- Exit velocities from pretreatment chambers shall be non-erosive (see Appendix D7 of the Vermont Stormwater Management Manual, Volume II-Technical Guidance) during the overbank flood events (i.e., Q_{p10}).
- Pretreatment Techniques to Prevent Clogging. Infiltration basins or trenches should have redundant methods to protect the long-term integrity of the infiltration rate. Three or more of the following techniques must be installed for infiltration basins or trenches:
 - Grass channel sized for the pretreatment volume (maximum velocity of 1 fps for water quality flow; see Section 2.7.4.C. for more detailed design information), or
 - Grass filter strip sized for the pretreatment volume (minimum 20 feet and only if sheet flow is established and maintained), and
 - Bottom sand layer
 - Upper sand layer (6" minimum with filter fabric at the sand/gravel interface-infiltration trench only)
 - Use of washed bank run gravel (2-5 inch diameter, typical) as aggregate (infiltration trench only)

Alternatively, a pre-treatment settling chamber may be provided and sized to capture the pretreatment volume. Use the method prescribed in section 2.7.4.C (i.e., the Camp-Hazen equation) to size the chamber.

Design Guidance

- The sides of infiltration trenches should be lined with an acceptable filter fabric that prevents soil piping.
- In infiltration trench designs, incorporate a fine gravel or sand layer above the coarse gravel treatment reservoir to serve as a filter layer.

2.7.3.D. Infiltration TreatmentRequired Elements

- Infiltration practices shall be designed to exfiltrate the entire WQ_v through the floor of each practice (sides are not considered in sizing).
- The construction sequence and specifications for each infiltration practice shall be precisely followed. Experience has shown that the longevity of infiltration practices is strongly influenced by the care taken during construction
- Calculate the surface area of infiltration trenches as:

$$A_p = V_w / (nd_t + fT/12)$$

Where:

| | | |
|-------|---|--|
| A_p | = | surface area (ft ²) |
| V_w | = | design volume (e.g., WQ_v) (ft ³) |
| n | = | porosity (assume 0.4) |
| d_t | = | trench depth (maximum of seven feet, and separated by at least three feet from seasonally high groundwater) (ft) |
| f_c | = | infiltration rate (in/hr) |
| T | = | time to fill trench or dry well (hours) (generally assumed to be less than 2 hours) |

Calculate the bottom surface area of trapezoidal infiltration basins using the following equation:

$$A_b = (2V_w - A_t d_b) / (d_b - P/6 + fT/6)$$

Where:

| | | |
|-------|---|--|
| A_b | = | surface area at the bottom of the basin (ft ²) |
| A_t | = | estimated area at the top of the basin (ft ²) |
| d_b | = | depth of the basin (ft) |
| P | = | design rainfall depth (inches) |

Design Guidance

- Infiltration practices are best used in conjunction with other practices, and often, downstream detention is still needed to meet the CP_v and Q_p sizing criteria.
- The aggregate for infiltration trenches should consist of clean, washed aggregate between 2 and 5 inches in diameter. The aggregate should be graded such that there will be few aggregates smaller than the selected size.
- The bottom of the infiltration trench stone reservoir should be completely flat so that infiltrated runoff will be able to infiltrate through the entire surface.
- Infiltration basins requiring embankments should follow the general design guidelines for ponds when considering sideslopes, riser location and other important features (see Appendix B1 of the Vermont Stormwater Management Manual, Volume II-Technical Guidance or other comparable guidance).

2.7.3.E. Infiltration Landscaping

Required Elements

- Upstream construction shall be completed and stabilized before connection to a downstream infiltration facility. A dense and vigorous vegetative cover shall be established over the contributing pervious drainage areas before runoff can be accepted into the facility.
- Infiltration trenches shall not be constructed until all of the contributing drainage area has been completely stabilized.

Design Guidance

- Mow upland and adjacent areas, and seed bare areas.

2.7.3.F. Infiltration Maintenance

Required Elements

- Infiltration practices shall never serve as a sediment control device during the site construction phase. In addition, the Erosion and Sediment Control plan for the site shall clearly indicate how sediment entry will be prevented from entering the site of an infiltration facility.
- An observation well shall be installed in every infiltration trench, consisting of an anchored six-inch diameter perforated PVC pipe with a screw top or lockable cap installed flush with the ground surface.
- Direct access shall be provided to infiltration practices for maintenance and rehabilitation.

Design Guidance

- A common method used to protect the infiltration facility during the construction phase involves using diversion berms around the perimeter of the infiltration practice, along with immediate vegetative stabilization and/or mulching.
- OSHA trench safety standards should be consulted if the infiltration trench will be excavated more than five feet.
- Infiltration basin designs should include dewatering methods in the event of failure. Dewatering can be accomplished with underdrain pipe systems that accommodate drawdown.
- If a stone reservoir or perforated pipe is used to temporarily store runoff prior to infiltration, the practice should not be covered by an impermeable surface unless manholes or other comparable access is provided.

2.7.3.G. Cold Climate Design Considerations

The following section provides design guidance for possible modifications to infiltration practices to reflect the severe winter climate in Vermont. This design guidance is **not mandatory** and site designers may consider these modifications on a case-by-case basis as a function of site conditions, receiving water sensitivity, or downstream flooding threat.

Because of additional challenges in cold climates, two issues warrant consideration to enhance system effectiveness:

- Reduced infiltration into frozen soils
- Chlorides from road salting operations

Reduced Infiltration

- Draining the ground beneath an infiltration system with an underdrain can increase cold weather soil infiltration.
- Another alternative is to divide the treatment volume between an infiltration STP and another STP to provide some treatment during the winter months.
- A seasonally operated infiltration/detention facility combines several techniques to improve the performance of infiltration STPs in cold climates. Two features, the underdrain system and level control valves, are sometimes used in cold climates. The level control valve is opened at the beginning of the winter season and the soil is allowed to drain. As the snow begins to melt in the spring, the underdrain and level control valves are closed, and the snowmelt is infiltrated until the capacity of the soil is reached. After this point, the facility acts as a detention facility, providing storage for particles to settle (Figure 2.13)

Chlorides

- Consider diverting snowmelt runoff past infiltration devices, especially in regions where chloride concentration in groundwater is a concern.
- Incorporate mulch into infiltration basin soil to mitigate problems with soil fertility.
- The selection of upland landscaping materials should include salt tolerant grasses where appropriate.

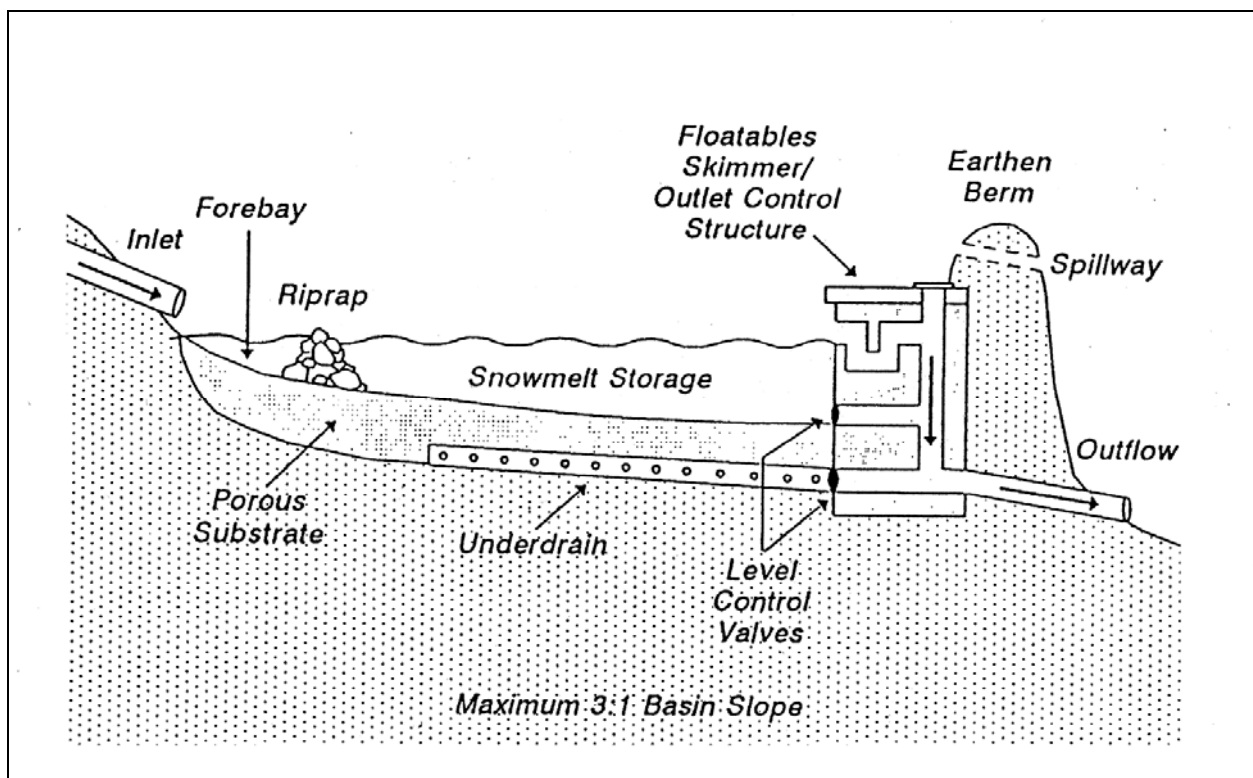

Figure 2.13 Seasonal Operation Infiltration Facility (Source: Oberts, 1994)

2.7.4 Stormwater Filtering Systems

Stormwater filtering systems capture and temporarily store the WQ_v and pass it through a filter bed of sand, organic matter, or soil. Filtered runoff may be collected and returned to the conveyance system, or allowed to partially exfiltrate into the soil. Design variants include:

| | | |
|-----|-------------------------|---------------|
| F-1 | Surface Sand Filter | (Figure 2.14) |
| F-2 | Underground Sand Filter | (Figure 2.15) |
| F-3 | Perimeter Sand Filter | (Figure 2.16) |
| F-4 | Organic Filter | (Figure 2.17) |
| F-5 | Bioretention | (Figure 2.18) |

Treatment Suitability: Filtering systems should not be designed to provide channel protection (CP_v) or stormwater detention (Q_p) except under extremely unusual conditions. Filtering practices should generally be combined with a separate facility to provide quantity controls.

Potential cold climate design modifications that address the primary concerns associated with filters in cold climates are provided at the end of this section. **The cold climate design modifications are presented as guidance only and are not required elements.** A more detailed discussion of cold climate modifications can be found in the publication *Stormwater BMP Design Supplement for Cold Climates* (Caraco & Claytor, 1997).

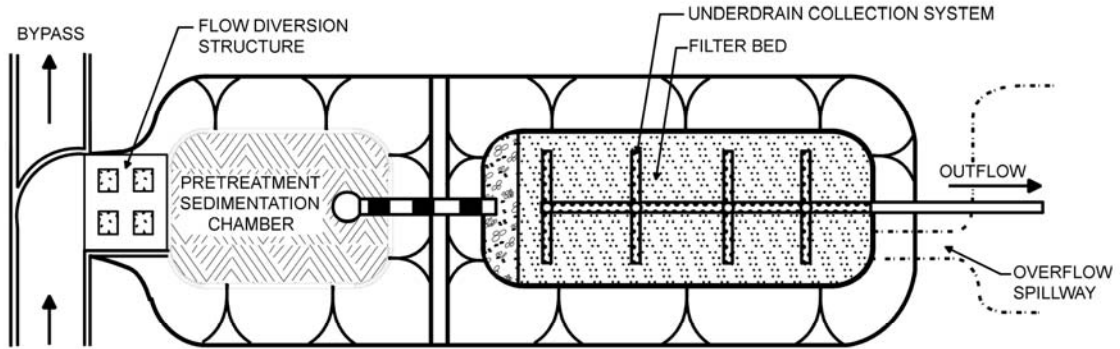

PLAN VIEW

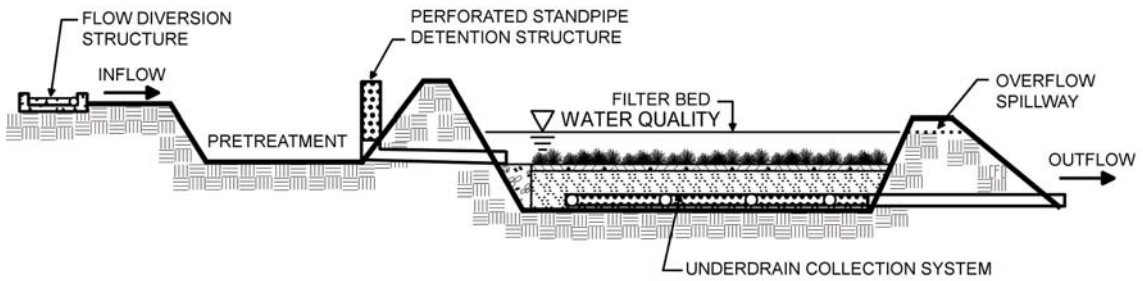

PROFILE

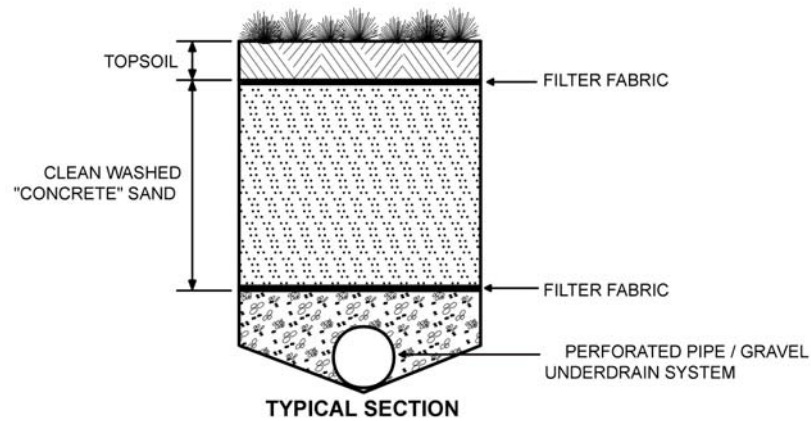

TYPICAL SECTION

Figure 2.14 Example of Surface Sand Filter (F-1)

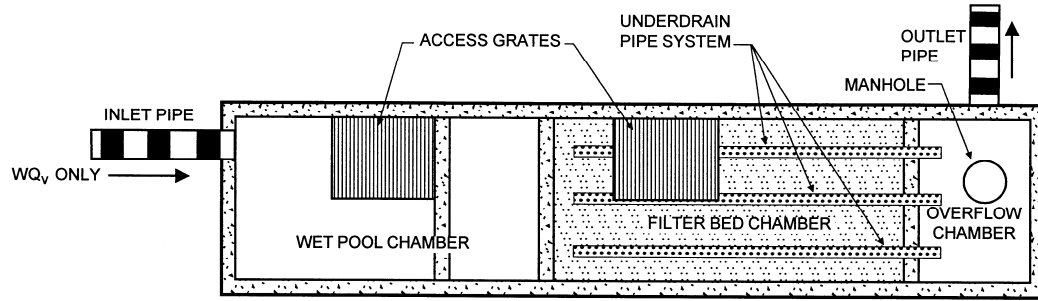

PLAN VIEW

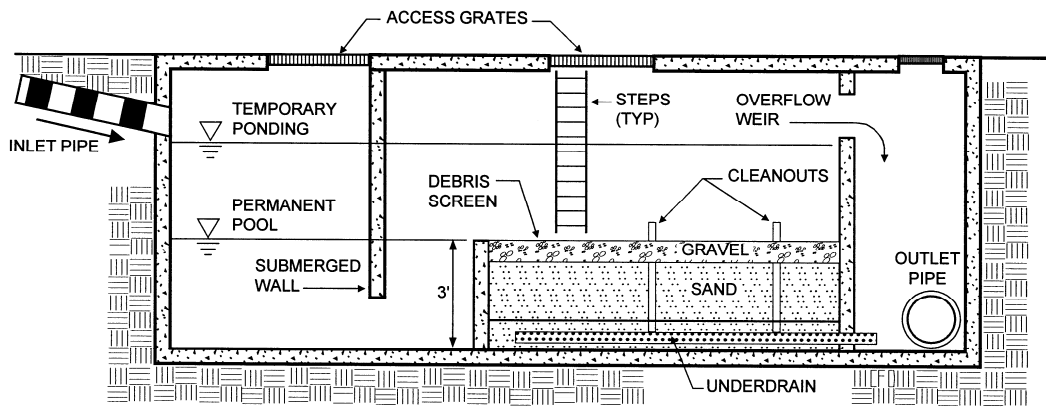

PROFILE

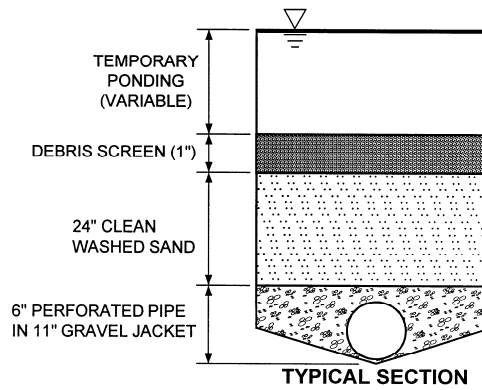

Figure 2.15 Example of Underground Sand Filter (F-2)

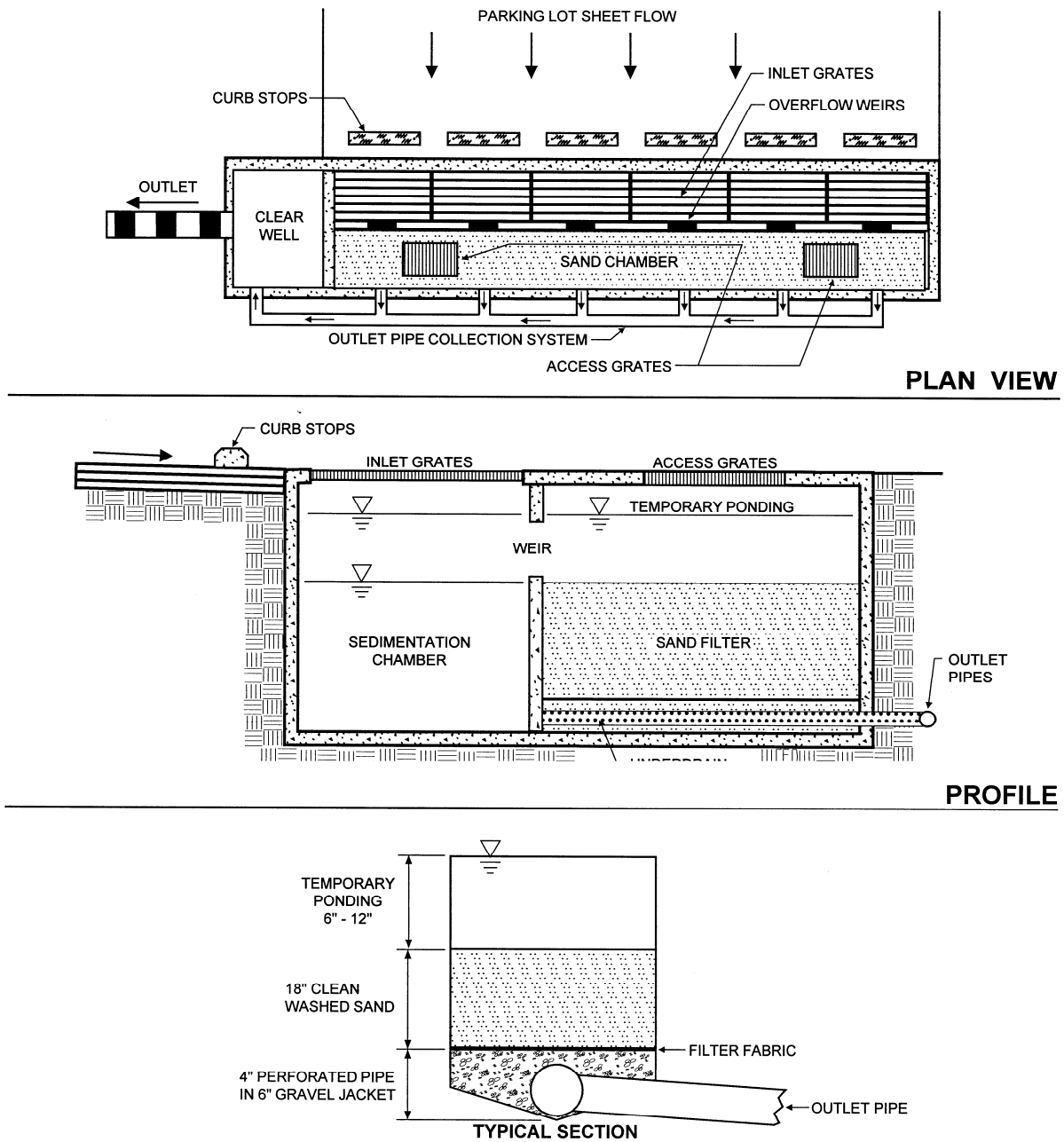
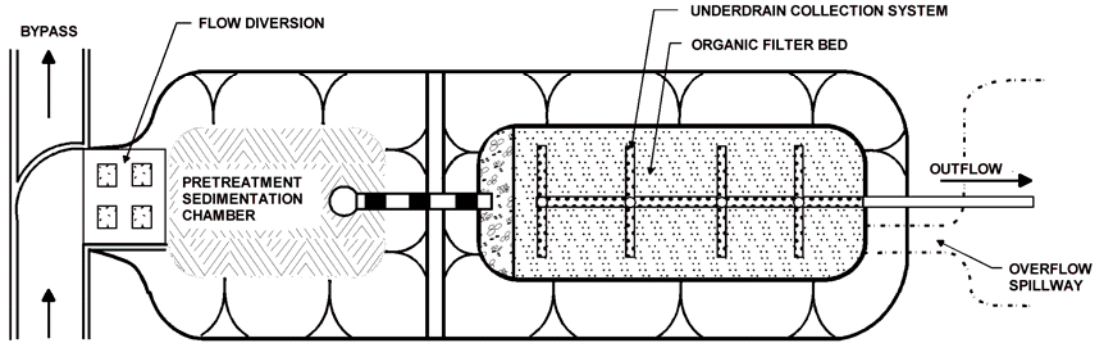
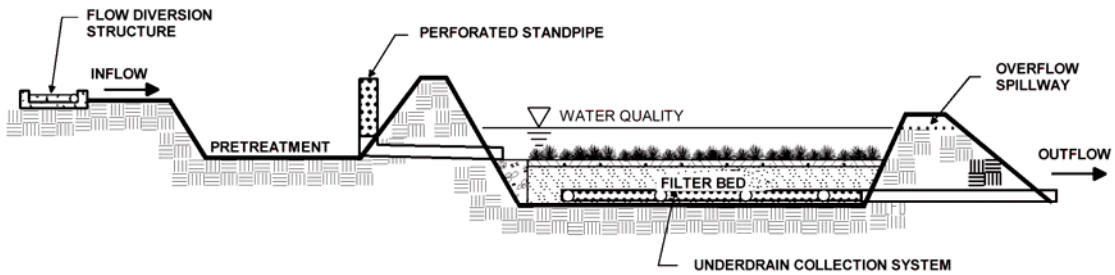

Figure 2.16 Example of Perimeter Sand Filter (F-3)



PLAN VIEW



PROFILE

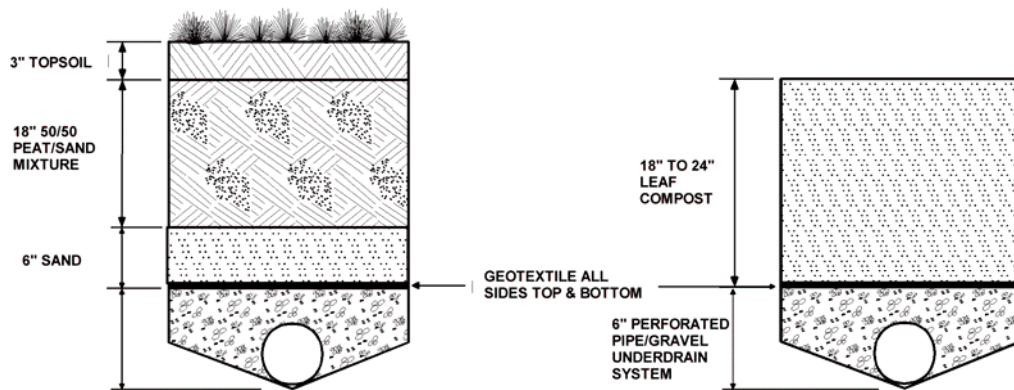

TYPICAL SECTIONS

Figure 2.17 Example of Organic Filter (F-4)

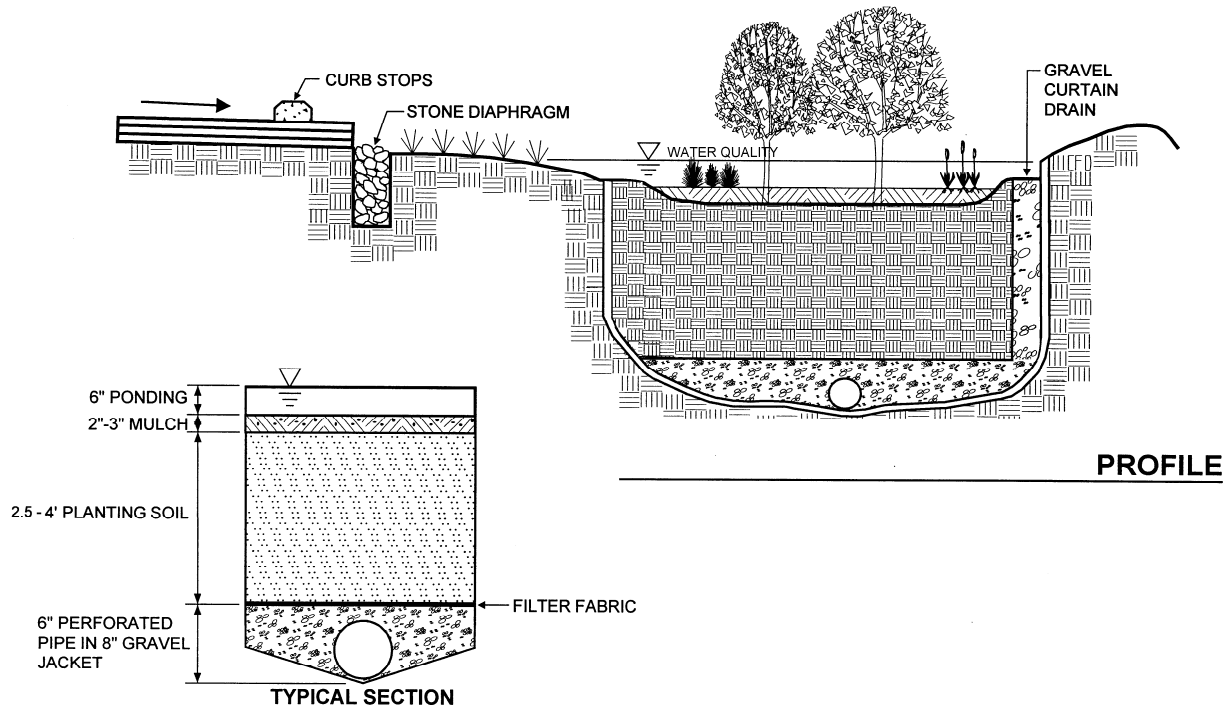
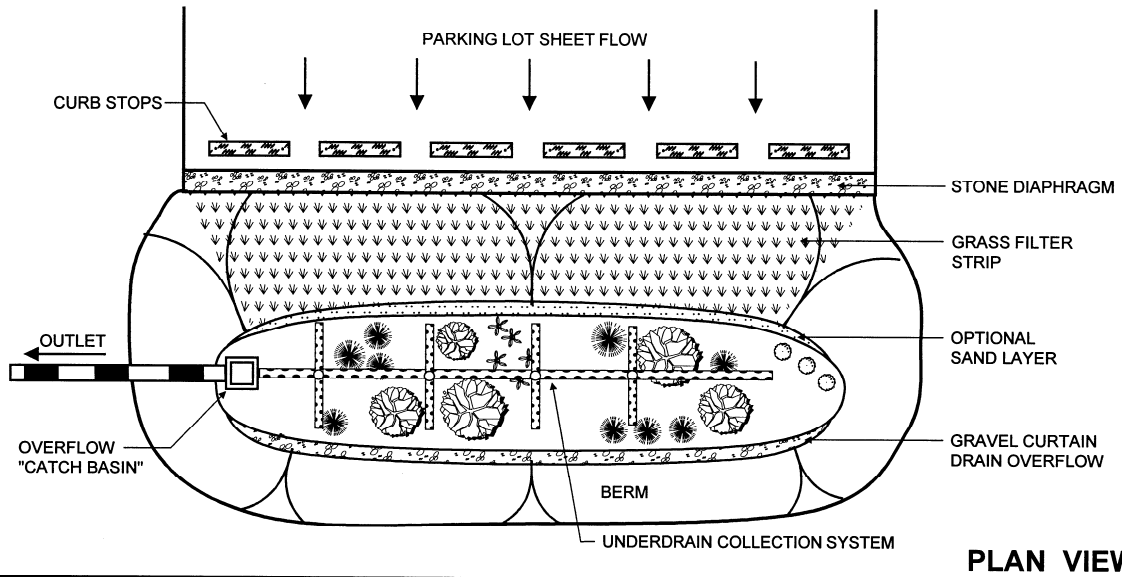

Figure 2.18 Example of Bioretention (F-5)

2.7.4.A. Filtering Feasibility

Design Guidance

- Most stormwater filters normally require four to six feet of head, depending on site configuration and land area available. The perimeter sand filter (F-3), however, can be designed to function with as little as 18" to 24" of head.
- The recommended maximum contributing area to an individual stormwater filtering system is usually less than 10 acres. In some situations, larger areas may be acceptable.
- Sand and organic filtering systems are generally applied to land uses with a high percentage of impervious surfaces.

2.7.4.B. Filtering Conveyance

Required Elements

- An overflow shall be provided within the practice to pass a percentage of the WQ_v to a stabilized water course. In addition, overflow for the 10-year storm shall be provided to a non-erosive outlet point (i.e., prevent downstream slope erosion).
- Stormwater filters shall be equipped with a minimum 4" perforated pipe underdrain (6" is preferred) in a gravel layer. A permeable filter fabric shall be placed between the gravel layer and the filter media.

Design Guidance

- A flow regulator (or flow splitter diversion structure) shall be supplied to divert the WQ_v to the filtering practice, and allow larger flows to bypass the practice (See Appendix D5 of the Vermont Stormwater Management Manual, Volume II-Technical Guidance).
- When designing the flow splitter, the designer should exercise caution to ensure that 75% of the WQ_v can enter the treatment system prior to flow bypass occurring at the flow splitter. The overflow weir between the sedimentation and filtration chambers may be adjusted to be lower in elevation than the flow splitter weir to minimize bypass of the filter system prior to inflow filling the 75% WQ_v storage.

2.7.4.C. Filtering Pretreatment

Pre-treatment of roof runoff is not required, provided the runoff is routed to the filtering practice in a manner such that it is unlikely to accumulate significant additional sediment (e.g via closed pipe system, or grass channel), and provided the runoff is not commingled with other runoff.

Required Elements for Design Variants F-1 – F-4

- Dry or wet pretreatment shall be provided prior to filter media treatment equivalent to at least 25% of the computed WQ_v . The typical method is a sedimentation basin that has a minimum length to width ratio of 1.5:1. The Camp-Hazen equation is used to compute the required surface area for sand and organic filters requiring full sedimentation for pretreatment (WSDE, 1992).

- The required sedimentation basin area is computed using the following equation:

$$A_s = -(Q_o/W) \times \ln(1-E)$$

Where:

- A_s = Sedimentation basin surface area (ft²)
- E = sediment trap efficiency (use 90%)
- W = particle settling velocity (ft/sec)
(use 0.0004 ft/sec for silt sized particles)
- Q_o = Discharge rate from basin = (WQ_v/24 hr)

Equation reduces to:

$$A_s = (0.066) (WQ_v) \text{ ft}^2$$

Design Guidance for Variant F-5

- Adequate pretreatment for bioretention systems should incorporate all of the following: (a) grass filter strip below a level spreader or grass channel, (b) gravel diaphragm and (c) a mulch layer.

Grass filter strip sizing

- The grass filter strip should be sized using the guidelines in Table 2.6.

Table 2.6 Guidelines for Filter Strip Pretreatment Sizing

| Parameter | Impervious Parking Lots | | | | Residential Lawns | | | |
|--------------------------------------|-------------------------|-----|-----|-----|-------------------|-----|-----|-----|
| | 35 | | 75 | | 75 | | 150 | |
| Maximum Inflow Approach Length (ft.) | 35 | | 75 | | 75 | | 150 | |
| Filter Strip Slope | ≤2% | ≥2% | ≤2% | ≥2% | ≤2% | ≥2% | ≤2% | ≥2% |
| Filter Strip Minimum Length | 10' | 15' | 20' | 25' | 10' | 12' | 15' | 18' |

Grass channel sizing

The grass channel should be sized using the following procedure (see example below):

- Determine the channel length needed to treat 100% of the WQ_v, using sizing techniques described in the open channel section (Section 2.7.5).
- Determine the volume directed to the channel for pretreatment.
- Determine the channel length by dividing the pretreatment volume by the WQ_v

Example: For a 1-acre site with 45% impervious cover (i.e., a runoff coefficient, R_v , of 0.43), the peak flow associated with the water quality rainfall of 0.9" is approximately 0.6 cfs. For a 2' wide (bottom width) channel with 3:1 sideslopes (horizontal:vertical) and a slope of 1%, the velocity is approximately 0.44 fps (this can be determined using nomographs, Manning's equation, or available computer software packages). Therefore, using a required residence time of 10 minutes (600 seconds), the required length of channel for 100% of the WQ_v would be $0.44 \text{ fps} \times 600 \text{ sec} = 264 \text{ ft}$. For pretreatment requirements, 25% of the WQ_v is needed, or $0.25 \times 264 \text{ ft} = 66 \text{ ft}$.

2.7.4.D. Filtering Treatment

Required Elements

- The entire treatment system (including pretreatment) shall be sized to temporarily hold at least 75% of the WQ_v prior to filtration.
- For design variants F-1 – F-4, the filter media shall consist of a medium sand (meeting ASTM C-33 concrete sand). Media used for organic filters may consist of peat/sand mix or leaf compost. Peat shall be a reed-sedge hemic peat.
- Bioretention systems (design variant F-5) shall consist of the following treatment components: A 2.5 to 4 foot deep planting soil bed, a surface mulch layer, and a six inch deep surface ponding area. Soils shall meet the design criteria outlined in Appendix A and B3 of the Vermont Stormwater Management Manual, Volume II-Technical Guidance.

Design Guidance

- The filter bed typically has a minimum depth of 18". The Perimeter Filter (F-3) may have a minimum filter bed depth of 12".
- The filter area for sand and organic filters should be sized based on the principles of Darcy's Law. A coefficient of permeability (k) should be used as follows:

| | |
|--------------------|---|
| Sand: | 3.5 ft/day (City of Austin, 1988) |
| Peat: | 2.0 ft/day (Galli, 1990b) |
| Leaf compost: | 8.7 ft/day (Claytor and Schueler, 1996) |
| Bioretention Soil: | 0.5 ft/day (Claytor and Schueler, 1996) |

(Note: the above values are conservative to account for clogging associated with accumulated sediment)

The filter bed and bioretention area is computed using the following equation:

$$A_f = (WQ_v) (d_f) / [(k) (h_f + d_f) (t_f)]$$

Where:

- A_f = Surface area of filter bed (ft²)
- d_f = Filter bed depth (ft)
- k = Coefficient of permeability of filter media (ft/day)
- h_f = Average height of water above filter bed (ft)
- t_f = Design filter bed drain time (days)
(1.67 days or 40 hours is the recommended maximum t_f for sand filters, 3 days for bioretention)

2.7.4.E. Filtering Landscaping

Required Elements

- A dense and vigorous vegetative cover shall be established over the contributing pervious drainage areas before runoff can be accepted into the facility.
- Landscaping is critical to the performance and function of bioretention areas. Therefore, a landscaping plan must be provided for bioretention areas (see Appendix A of the Vermont Stormwater Management Manual, Volume II-Technical Guidance).

Design Guidance

- Surface filters can have a grass cover to aid in pollutant adsorption. The grass should be capable of withstanding frequent periods of inundation and drought.
- Planting recommendations for bioretention facilities are as follows:
- Native plant species should be specified over non-native species.
- Vegetation should be selected based on a specified zone of hydric tolerance.
- A selection of trees with an understory of shrubs and herbaceous materials should be provided.
- Woody vegetation should not be specified at inflow locations.
- Trees should be planted primarily along the perimeter of the facility.
- A tree density of approximately one tree per 100 square feet (i.e., 10 feet on-center) is recommended. Shrubs and herbaceous vegetation should generally be planted at higher densities (five feet on-center and 2.5 feet on center, respectively).

2.7.4.F. Filtering Maintenance

Required Elements

- A legally binding and enforceable maintenance agreement shall be executed between the facility owner and the local review authority to ensure the following:
- Sediment shall be cleaned out of the sedimentation chamber when it accumulates to a depth of more than six inches. Vegetation within the sedimentation chamber shall be limited to a height of 18 inches. The sediment chamber outlet devices shall be cleaned/repared when drawdown times exceed 36 hours. Trash and debris shall be removed as necessary.
- Silt/sediment shall be removed from the filter bed when the accumulation exceeds one inch. When the filtering capacity of the filter diminishes substantially (i.e., when water ponds on the surface of the filter bed for more than 48 hours), the top few inches of discolored material shall be removed and shall be replaced with fresh material. The removed sediments shall be disposed in an acceptable manner (i.e., landfill).
- A stone drop (i.e., pea gravel diaphragm) of at least six inches shall be provided at the inlet of bioretention facilities (F-5). Areas devoid of mulch shall be re-mulched on an annual basis. Dead or diseased plant material shall be replaced.

Design Guidance

- Organic filters or surface sand filters that have a grass cover should be mowed as needed during the growing season to maintain maximum grass heights less than 12 inches.
- Annual maintenance required for bioretention areas is to include: pruning of vegetation, remulching, and soil aeration.

2.7.4.G. Cold Climate Design Considerations

The following section provides design guidance for possible modifications to filters to reflect the severe winter climate in Vermont. This design guidance is not mandatory, with the exception of underdrain standards in "Pipe Freezing" and all standards listed in "Road Sand Build-Up", but site designers may consider these modifications on a case-by-case basis as a function of site conditions, receiving water sensitivity, or downstream flooding threat.

In cold climates, stormwater filtering systems need to be modified to protect the systems from freezing and frost heaving. Three cold climate considerations that apply to filtering systems are:

- Freezing of the filter bed
- Pipe freezing
- Clogging of filter

Note: Although filtering systems are not as effective during the winter, they are often effective at treating storm events in areas where other STPs are not practical, such as in highly urbanized regions. Thus, they may be a good design option, even if winter flows cannot be treated. It is also important to remember that these STPs are designed for highly impervious areas. If the snow from the contributing areas is transported to another area, such as a pervious infiltration area, their performance during the winter season is less critical to obtain water quality goals.

Freezing of the Filter Bed

- Place filter beds for underground filters below the frost line to prevent the filtering medium from freezing during the winter.
- Discourage organic filters using peat and compost media, which are ineffective during the winter in cold climates. These organic filters retain water, and consequently can freeze solid and become completely impermeable and less likely to thaw as quickly as other filters during the spring melt.
- Combine treatment with another STP option that can be used as a backup to the filtering system to provide treatment during the winter when the filter bed is frozen.

Pipe Freezing

- Use a minimum 8" underdrain diameter in a 1' gravel bed. Increasing the diameter of the underdrain makes freezing less likely, and provides a greater capacity to drain standing water from the filter. The porous gravel bed prevents standing water in the system by promoting drainage. Gravel is also less susceptible to frost heaving than finer grained media.
- Replace vertical standpipe with weirs, which are less likely to clog with ice. Although weir structures will not provide detention, they can provide retention storage (i.e., storage with a permanent pool) in the pretreatment chamber.

Clogging of Filter with Excess Sand from Runoff

- If a filter is used to treat runoff from a parking lot or roadway that is frequently sanded during snow events, there is a high potential for clogging from sand in runoff. In these cases, the size of the pretreatment chamber should be increased to 40% of the treatment volume. For bioretention systems, a grass strip, such as a swale, of at least twenty-five feet in length should convey flow to the system.
- **Filters should always be inspected for sand build-up in the filter chamber following the spring melt event.**

2.7.5 Open Channel Systems

Open channel systems are vegetated open channels that are explicitly designed to capture and treat the full WQ_v within dry or wet cells formed by check dams or other means. Design variants include:

| | | |
|-----|---------------|---------------|
| O-1 | Dry Swale | (Figure 2.19) |
| O-2 | Wet Swale | (Figure 2.20) |
| O-3 | Grass Channel | (Figure 2.21) |

Treatment Suitability: Most Open Channel Systems can meet recharge (O-1 and O-3) and water quality treatment goals, but are not appropriate for CP_v or Q_p .

Potential cold climate design modifications that address the primary concerns associated with open channel systems in cold climates are provided at the end of this section. **The cold climate design modifications are presented as guidance only and are not required elements.** A more detailed discussion of cold climate modifications can be found in the publication Stormwater BMP Design Supplement for Cold Climates (Caraco & Claytor, 1997).

Note: dry swales and grass channels, while both considered open channel system variants, are fundamentally different in terms of their design approach. Specifically, dry swales are essentially a linear filter system that is a function of a volume-based designs. Grass channels are conveyance systems that can provide water quality treatment based on rate-based design criteria.

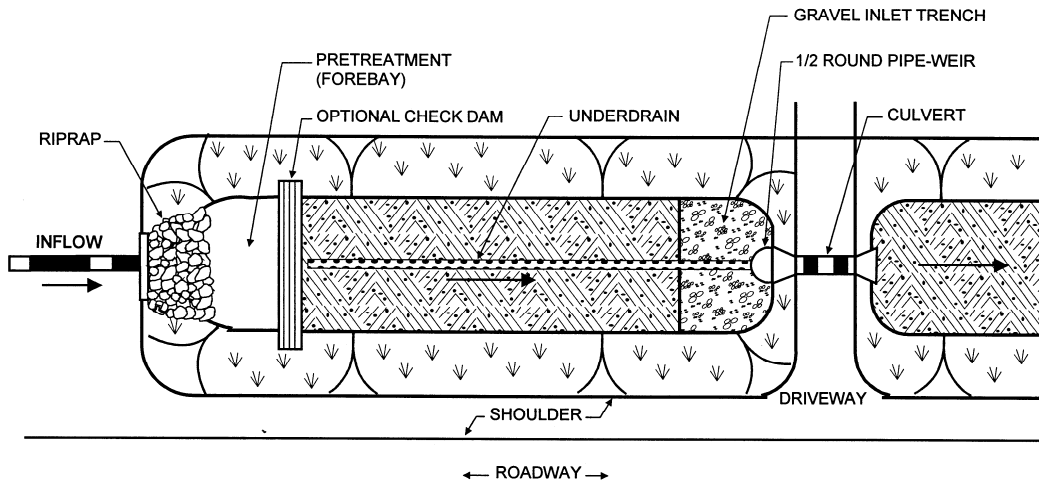

PLAN VIEW

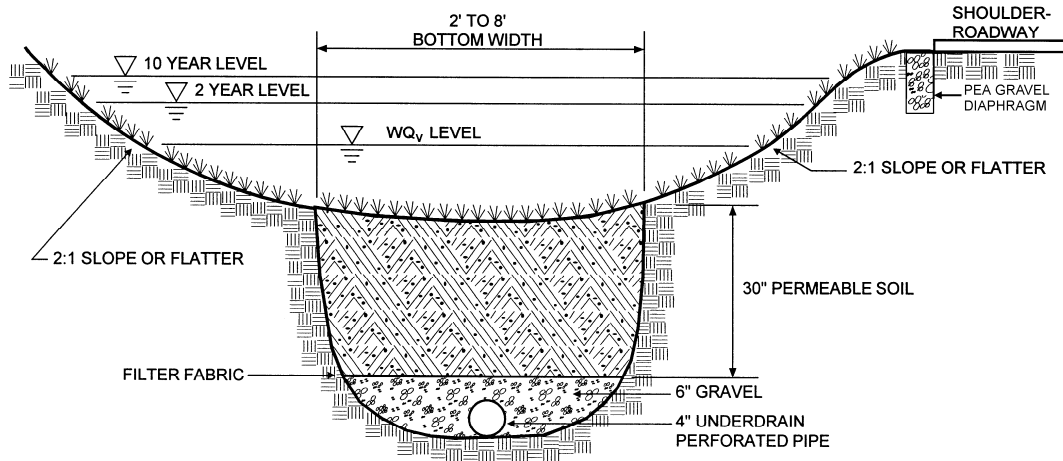

SECTION

Figure 2.19 Example of Dry Swale (O-1)

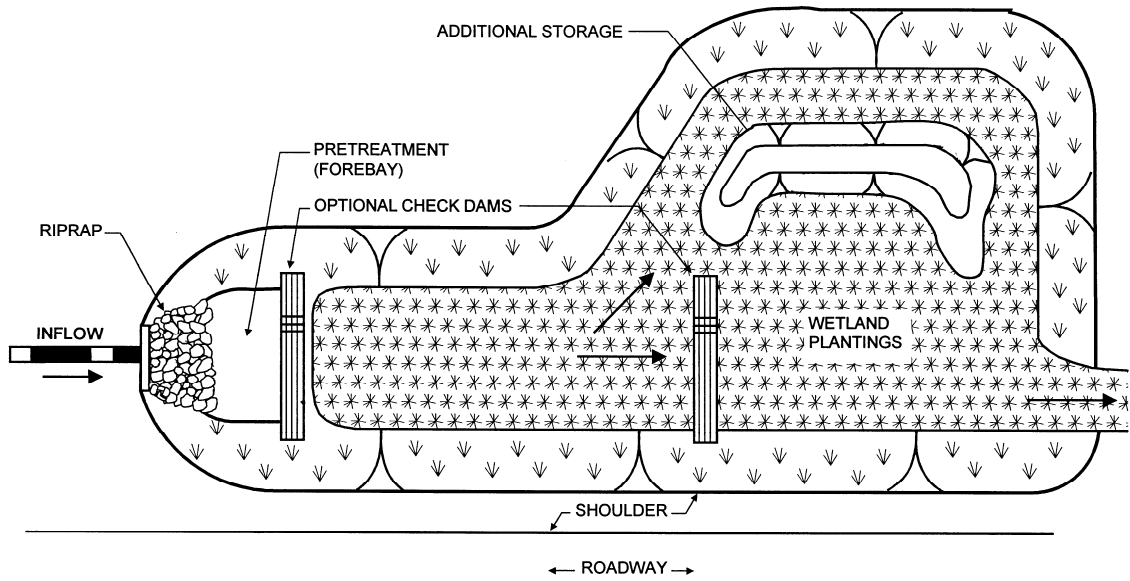

PLAN VIEW

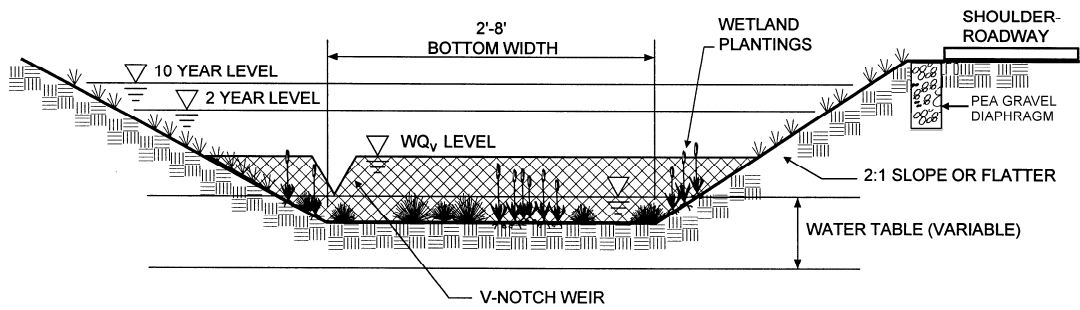

PROFILE

Figure 2.20 Example of Wet Swale (O-2)

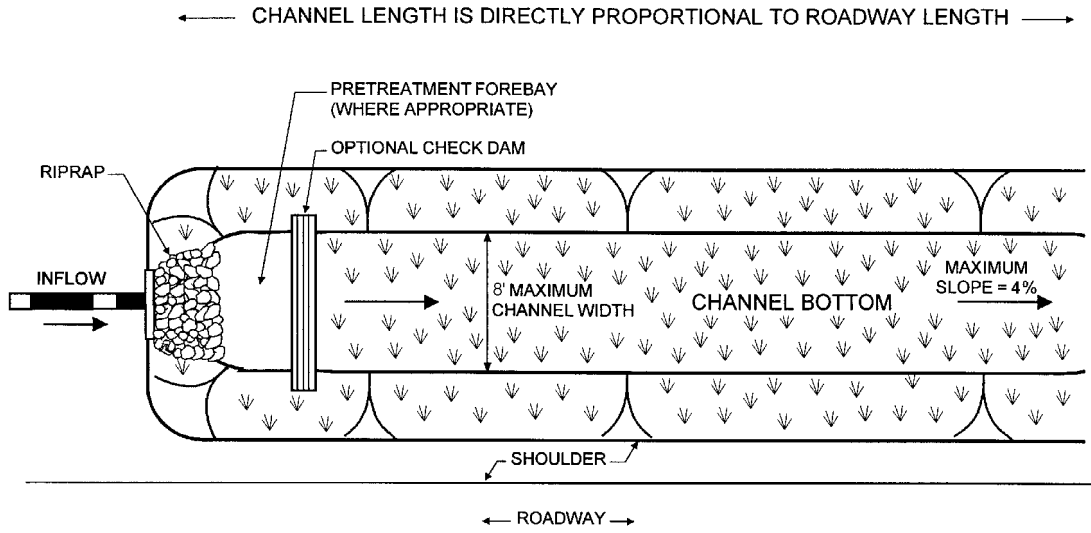

PLAN VIEW

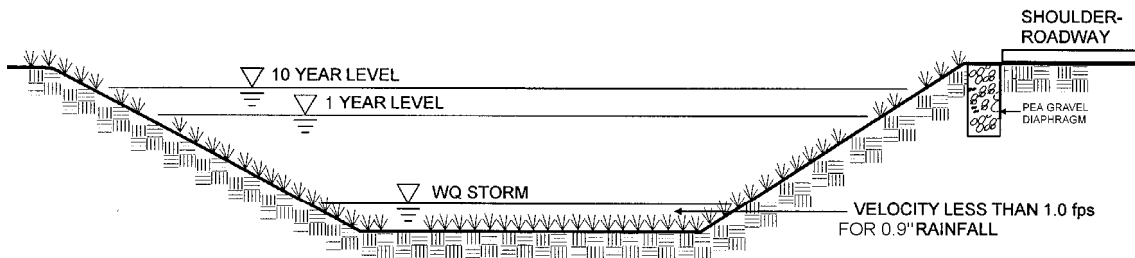

SECTION

Figure 2.21 Example of Grass Channel (O-3)

2.7.5.A. Open Channel Feasibility

Required Elements

- The system shall have a maximum longitudinal slope of 4.0%

Design Guidance

- Dry swales and grass channels are primarily applicable for land uses such as roads, highways, residential development, and pervious areas.
- Wet swales should be restricted in residential areas because of the potential for stagnant water and other nuisance ponding.

2.7.5.B. Open Channel Conveyance

Required Elements

- The peak velocity for the 1-year storm must be non-erosive (see Appendix D7 of the Vermont Stormwater Management Manual, Technical Guidance)
- Open channels shall be designed to safely convey the 10-year storm with a minimum of 6 inches of freeboard.
- The maximum allowable temporary ponding time within a channel shall be less than 40 hours. An under-drain system shall be used in the dry swale to ensure this ponding time.
- Channels shall be designed with moderate side slopes (flatter than 3:1) for most conditions. 2:1 is the absolute maximum side slope.
- Size grass channels using Manning's equation (NRCS, 1986; Claytor and Schueler, 1996). Use an "n" value of 0.15 for flow depths of 4" or smaller, and linearly decrease to 0.03 for a depth of 12" (see Appendix D7 of the Vermont Stormwater Management Manual, Volume II-Technical Guidance, Figure D.14).

Design Guidance

- Open channel systems that directly receive runoff from impervious surfaces should have a 6-inch drop onto a protected shelf (pea gravel diaphragm) to minimize the clogging potential of the inlet.
- The underdrain system of a dry swale should be composed of a 6" gravel bed with a 4" PVC pipe.
- If the site slope is greater than 2%, check dams may be needed to retain the water quality volume within the open channel system. Check dams are typically 6- to 12-inch vertical drops that can be constructed of wood, small diameter stone, concrete, or earth.

2.7.5.C. Open Channel Pretreatment

Pre-treatment of roof runoff is not required, provided the runoff is routed to the channel in a manner such that it is unlikely to accumulate significant additional sediment (e.g via closed pipe system, or grass channel), and provided the runoff is not commingled with other runoff.

Design Guidance

- Provide 10% of the WQ_v in pretreatment. This storage is usually obtained by providing checkdams at pipe inlets and/or driveway crossings.
- Utilize a pea gravel diaphragm and gentle side slopes along the top of channels to provide pretreatment for lateral sheet flows.

2.7.5.D. Open Channel Treatment

Required Elements

- Wet and dry swale length, width, depth, and slope shall be designed to temporarily accommodate the WQ_v through surface ponding.
- For the dry swale, the treatment design criteria are similar to those of a filter. The surface area of the swale bottom should be sized to drain the WQ_v within 40 hours (Darcy's equation in Section 2.7.4.D. should be used for this sizing). The average head should not exceed 12 inches. To ensure that adequate head builds up on the filter media, the WQ_v should be released over a minimum of 30 minutes.
- For grass channels, the treatment design criteria are rate-based. Sufficient length should be provided to detain the peak discharge associated with the water quality rainfall depth (i.e., 0.9"—see Appendix D6 of the Vermont Stormwater Management Manual, Volume II-Technical Guidance) for an average residence time of 10 minutes, at a velocity of no greater than 1 ft/s, and at a depth generally no greater than 4". Check dams may be required to meet this criterion. (Note: the average residence time should be verified at the midpoint of the channel length, see the design example for a grass channel, Appendix C4 of the Vermont Stormwater Management Manual, Volume II-Technical Guidance).
- Design with a bottom width no greater than 8 feet to avoid potential gullying and channel braiding, but not less than 2 feet.
- Soil media for the dry swale should be moderately permeable and shall meet the specifications outlined in Appendix B3 of the Vermont Stormwater Management Manual, Volume II-Technical Guidance.

Design Guidance

- Open channels should maintain a maximum ponding depth of 1 foot at the mid-point of the channel, and a maximum depth of 18" at the end point of the channel (for storage of the WQ_v).

2.7.5.E. Open Channel Landscaping

Design Guidance

- Landscape design should specify proper grass species and wetland plants based on site-specific soils and hydric conditions present along the channel. (See Appendix A of the Vermont Stormwater Management Manual, Volume II-Technical Guidance for landscaping guidance).

2.7.5.F. Open Channel Maintenance

Required Elements

- A legally binding and enforceable maintenance agreement shall be executed between the facility owner and the local review authority to ensure the following:
- Sediment build-up within the bottom of the channel is removed when 25% of the original WQ_v volume has been exceeded.
- Vegetation in dry swales is mowed as required during the growing season to maintain grass heights in the 4 to 6 inch range.

Design Guidance

- Correct erosion gullies as needed to maintain a healthy stand of vegetation.

2.7.5.G. Cold Climate Design Considerations

The following section provides design guidance for possible modifications to open channels to reflect the severe winter climate in Vermont. This design guidance is not mandatory, with the exception of “Culvert Freezing” and “The Impact of Deicers on Channel Vegetation”, but site designers may consider these modifications on a case-by-case basis as a function of site conditions, receiving water sensitivity, or downstream flooding threat.

For open channel systems, three cold climate design challenges need to be addressed:

- Snowmelt infiltration on frozen ground
- Culvert freezing
- The impacts of deicers on channel vegetation.

Snowmelt Infiltration on Frozen Ground

- For dry swales, in order to ensure that the filter bed remains dry between storm events, increase the size of the underdrain pipe to a minimum diameter of 6” with a minimum 1’ filter bed.
- The soil bed permeability of the dry swale should be USCS class SW or SM (NRCS, 1984), which is slightly higher than in the base criteria. This increased permeability will encourage snowmelt infiltration.

Culvert Freezing

- Use culvert pipes with a minimum diameter of 18”.
- Design culverts with a minimum 1% slope where possible.

The Impacts of Deicers on Channel Vegetation

- Inspect open channel systems after the spring melt. At this time, residual sand should be removed and any damaged vegetation should be replaced.
- If roadside or parking lot runoff is directed to the practice, mulching and/or soil aeration/manipulation may be required in the spring to restore soil structure and moisture capacity to reduce the impacts of deicing agents.
- Use salt-tolerant plant species in vegetated swales (See Appendix A of the Vermont Stormwater Management Manual, Volume II-Technical Guidance).

2.8 Limited Applicability Stormwater Management Practices

As previously described, there is a suite of stormwater management practices that have limited applicability either because they only provide water quantity control capabilities or because they have limited water quality treatment capabilities (i.e., current independent studies do not support their inclusion in the list of acceptable practices). Design variants include:

| | | |
|------|---|---------------|
| LA-1 | Dry Detention Pond | (Figure 2.22) |
| LA-2 | Underground Storage Vault | (Figure 2.23) |
| LA-3 | Hydrodynamic/Swirl Concentrator Devices | (Figure 2.24) |
| LA-4 | Oil and Grit Separators | (Figure 2.25) |
| LA-5 | Filter Strip | (Figure 2.26) |

Treatment Suitability: Dry detention ponds (LA-1) and underground storage vaults (LA-2) are designed to provide channel protection (CP_v), overbank (Qp_{10}), and extreme flood (Qp_{100}) control only. They are not suitable for meeting water quality or recharge criteria as stand alone best management practices.

Hydrodynamic/swirl concentrator devices (LA-3) are appropriate for pretreatment requirements only, and do not meet the full water quality requirement or the recharge requirement. Section 2.5 describes the conditions required for practices, such as LA-3, to be added to the list of approved water quality practices.

Oil and grit separators (LA-4) are presented in this section as a potential spill containment practice that might be used for hot spot land uses. These practices do not meet water quality, recharge, or pretreatment requirements.

Filter strips (LA-5) are appropriate for pretreatment and can meet the recharge requirement under the Percent Area Method (see Section 1.1.3).

Design guidance is provided for these limited application practices, however, not at the same level of detail as the practices acceptable to meet water quality requirements. In cases where the practice is a proprietary product, specifications and design criteria can typically be obtained from vendors.

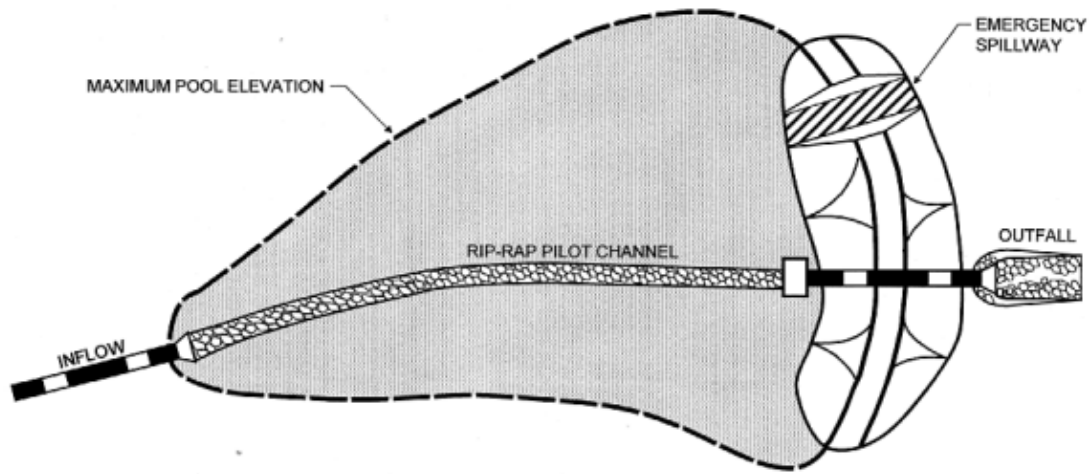

PLAN VIEW

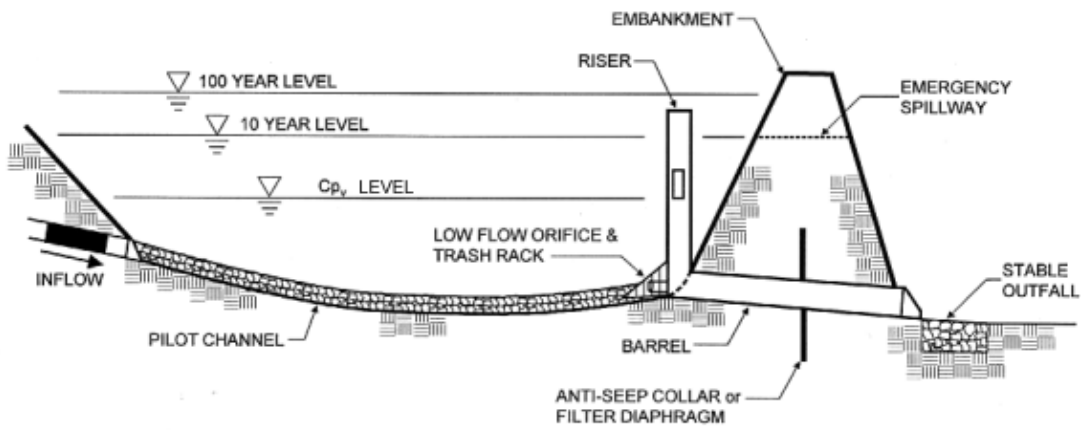

PROFILE

Figure 2.22 Example of Dry Detention Pond (LA-1)

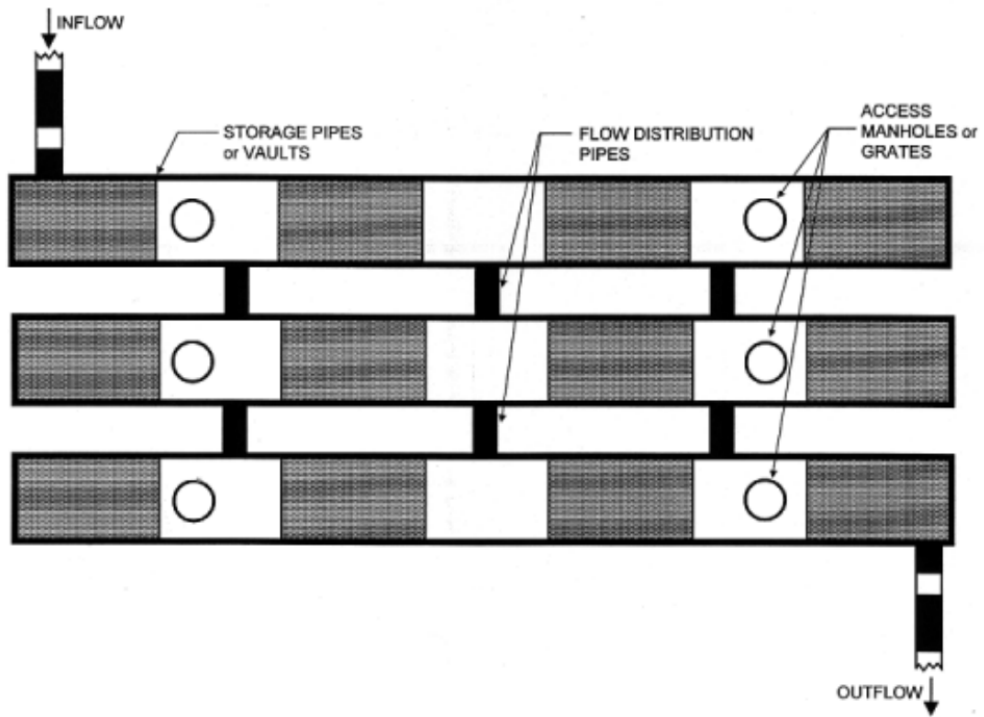

PLAN VIEW

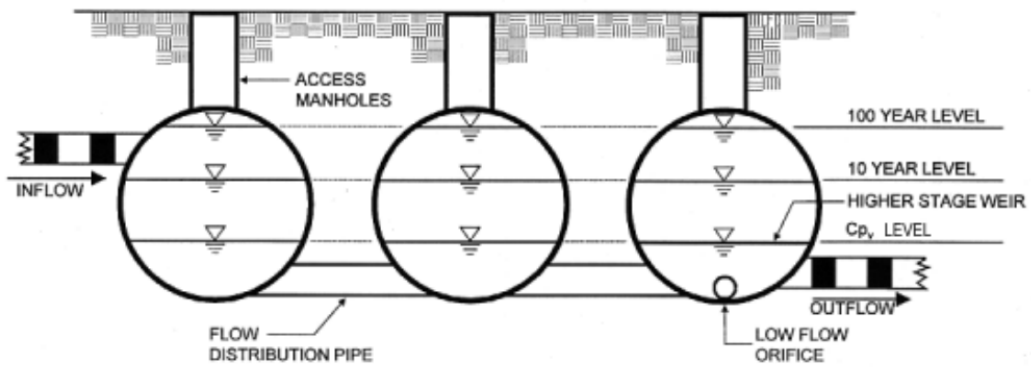

TYPICAL SECTION

Figure 2.23 Example of Underground Storage Vault (LA-2)

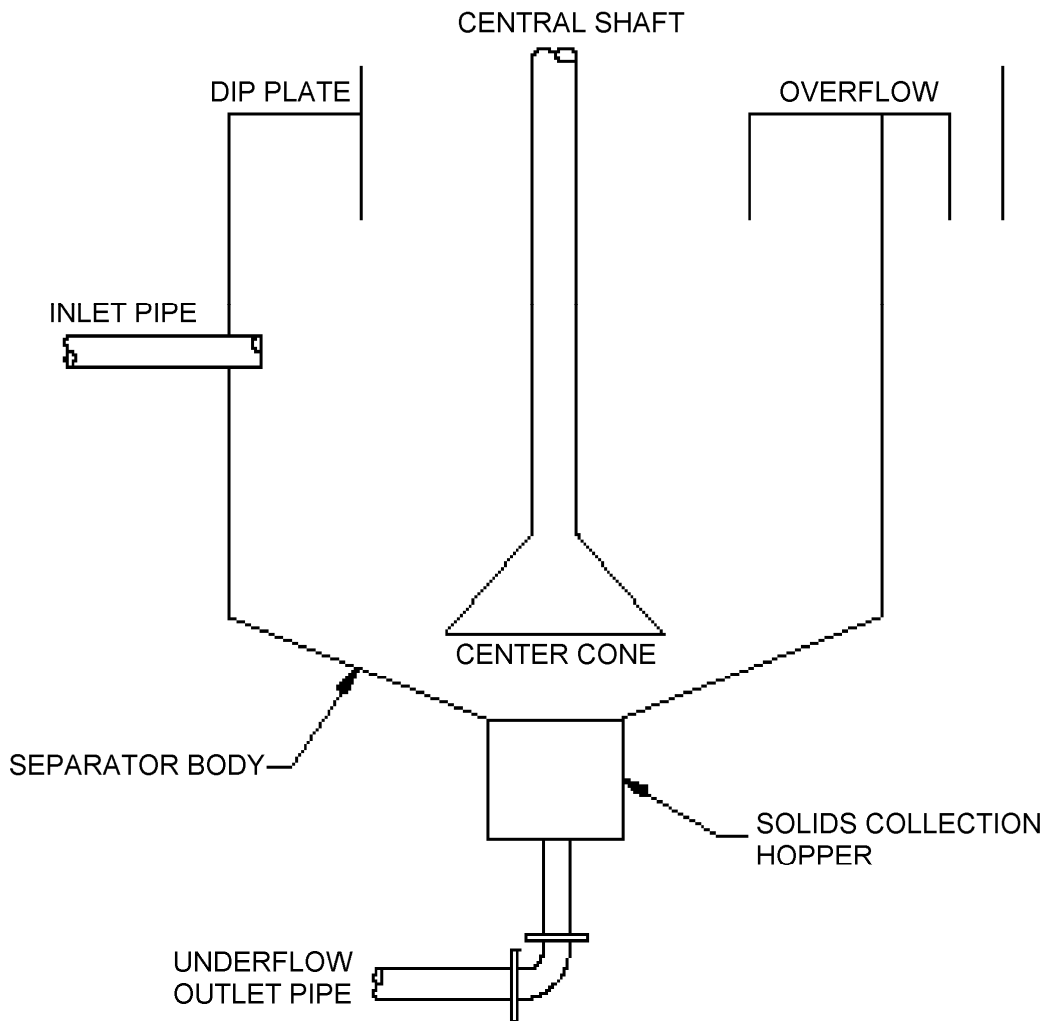

Figure 2.24 Example of Hydrodynamic Device (LA-3)

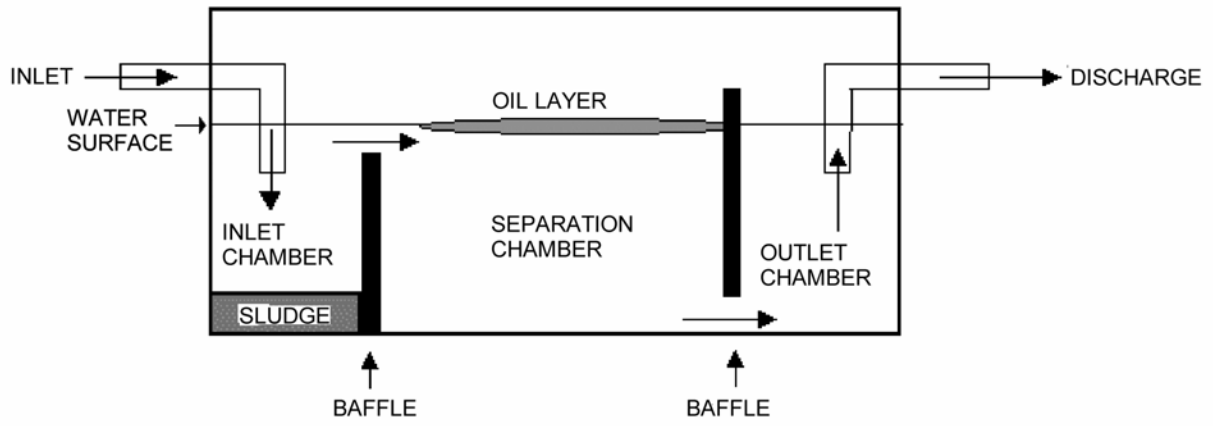
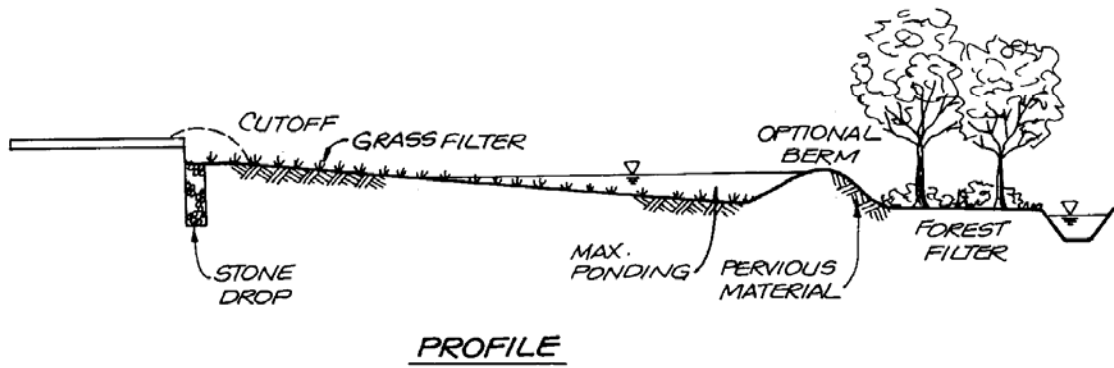
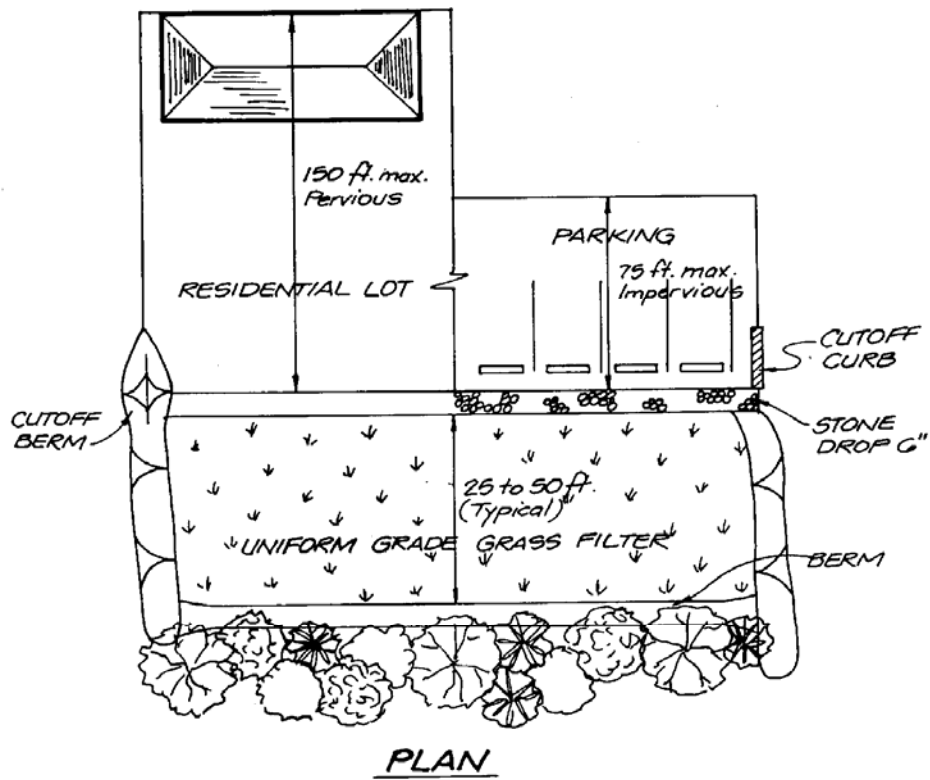

Figure 2.25 Example of Oil and Grit Separators (LA-4)



Section 3 – Voluntary Stormwater Management Credits

3.0 Introduction

The unified sizing criteria described in Section 1 have been developed to provide a strong incentive to reduce impervious cover at a site. All five sizing criteria (water quality (WQ_v), recharge (Re_v), channel protection (CP_v), overbank control (Q_{p10}), and when applicable, extreme flood control (Q_{p100})) are directly related to impervious cover. A reduction in impervious cover results in reduced storage volume requirements and, consequently, less land consumption and lower construction costs.

In an effort to apply a more comprehensive site-design approach to stormwater management, six specific non-structural practices are set forth in this chapter which, if used properly, can result in the granting of a *stormwater credit to a site designer*. *A stormwater credit can reduce the required water quality and recharge storage volumes*, thereby reducing the size and cost of structural STPs.

The use of the practices set forth in this section to obtain stormwater credits is strictly optional and voluntary.

Stormwater credits can be obtained through the use of the following six groups of non-structural practices:

- Credit 1. Natural Area Conservation
- Credit 2. Disconnection of Rooftop Runoff
- Credit 3. Disconnection of Non-Rooftop Runoff
- Credit 4. Stream Buffers
- Credit 5. Grass Channels
- Credit 6. Environmentally Sensitive Rural Development

This section describes each of the credits for the six groups of non-structural practices and specifies minimum criteria to be eligible for the credit. A site designer should check local zoning and subdivision codes to ensure that a credit can be used in the local jurisdiction.

Non-structural practices are increasingly recognized as a critical feature of effective stormwater management, particularly with respect to site design. In most cases, non-structural practices will need to be combined with structural practices to meet stormwater requirements. The key benefit of non-structural practices is that they can reduce the generation of stormwater from the site. In addition, they can provide partial removal of many pollutants and contribute to groundwater recharge. In general, applying these credits will result in meeting some or all of the recharge requirements (Re_v) under the Percent Area Method, and partially meeting the water quality requirement (WQ_v).

The application of these credits does not relieve the site designer from the standard of engineering practice associated with safe conveyance and drainage design.

3.1 Natural Area Conservation Credit

A stormwater credit is given when natural areas are conserved at development sites, thereby retaining their pre-development hydrologic and water quality characteristics. A simple WQ_v credit (reduction in the required water quality volume) is granted for all conservation areas protected under the terms of the permit or other locally acceptable means. Examples of natural area conservation include:

- Forest retention areas
- Wetlands, vernal pools and associated buffers
- Other lands in protective easement (e.g., floodplains, undisturbed open space)

To the extent practicable, these natural areas should be delineated to maximize contiguous land and avoid fragmentation. Under the credit, a designer can subtract conservation areas from total site area when computing the water quality volume. The volumetric runoff coefficient, R_v , is still calculated based on the percent impervious cover for the entire site, including the conserved portion.

As an additional incentive, the post development curve number¹³ (CN) used to compute the CP_v , Q_{p10} , and Q_{p100} for all natural areas protected under the terms of the permit or other locally acceptable means can be assumed to be forest in good condition.

As an example, the required WQ_v for a ten-acre site with three acres of impervious area and three acres of protected conservation area before the credit would be:

$$R_v = 0.05 + 0.009(30) = 0.32$$

$$WQ_v = (0.9 \text{ inch}) (0.32) (10 \text{ acres})/12 = 0.24 \text{ acre-feet.}$$

Under the credit, three acres of conservation are subtracted from total site area, which yields a smaller storage volume:

$$WQ_v = (0.9 \text{ inch}) (0.32) (7 \text{ acres})/12 = 0.17 \text{ acre-feet.}$$

The recharge requirement (Re_v) is not reduced using this credit.

Criteria for Natural Area Credit

To receive the credit, the proposed conservation area:

- Cannot be disturbed during project construction (i.e., cleared or graded, except for temporary disturbances for utility construction).
- Must be protected by limits of disturbance clearly shown on all construction drawings.

¹³ Curve numbers are input parameters to the NRCS unit hydrograph procedure used in TR-55 and TR-20 that calculates runoff as a function of rainfall and travel time (i.e., time of concentration). Curve numbers are based on soils, plant cover, amount of impervious areas, interception, and surface storage. The higher the curve number, the greater the runoff from a drainage area.

- Must be maintained in the natural vegetative state and restricted from development and disturbance for the life of the applicable stormwater permit. (Note: managed turf is not an acceptable form of vegetation management).

See Section 3.8 for an example application of the natural area conservation credit.

3.2 Disconnection of Rooftop Runoff Credit

A credit is given when rooftop runoff is “disconnected” and then directed over to a pervious area where it can either infiltrate into the soil or flow over it with sufficient time and velocity to allow for filtering. The credit is typically obtained by grading the site to promote overland flow through vegetated channels or by providing bioretention areas either on-lot or in common areas.

If a rooftop is adequately disconnected, the disconnected impervious area can be deducted from total impervious cover (therefore reducing WQ_v). In addition, disconnected rooftops can be used to meet the Re_v requirement as a non-structural practice under the Percent Area Method.

Restrictions on the Credit

The rooftop disconnection credit is subject to the following restrictions:

- Disconnection must be designed to adequately address the issue of basement seepage.
- The contributing length of rooftop to a discharge location shall be 75 feet or less.
- The rooftop contributing area to any one discharge location cannot exceed 1,000 ft²
- The length of the “disconnection” shall be equal to or greater than the contributing rooftop length.
- Disconnections will only be credited for residential lot sizes greater than 6,000 sq. ft.
- The entire vegetative “disconnection” shall be on a slope less than or equal to 5.0%.
- Where provided, downspouts must be at least 10 feet away from the nearest impervious surface to discourage “re-connections.”
- Where a gutter/downspout system is not used, the rooftop runoff must drain as either sheetflow from the structure or drain to a subsurface drain field that is not directly connected to the drainage network.
- Disconnections are encouraged on relatively permeable soils (HSG A and B); therefore, no soil evaluation is required.
- In less permeable soils (HSG C and D), the water table depth and permeability shall be evaluated by a professional engineer to determine if a spreading device is needed to provide sheetflow over grass surfaces. In some cases, dry wells (see Figure3.1), french drains or other temporary underground storage devices may be needed to compensate for a poor infiltration capability.
- For those rooftops draining directly to a stream buffer, one can only use either the rooftop disconnection credit or the stream buffer credit (Credit 4), not both.
- To take credit for rooftop disconnection for a designated hotspot land use, the rooftop runoff must not co-mingle with runoff from any paved surfaces.

An example of this credit is provided below.

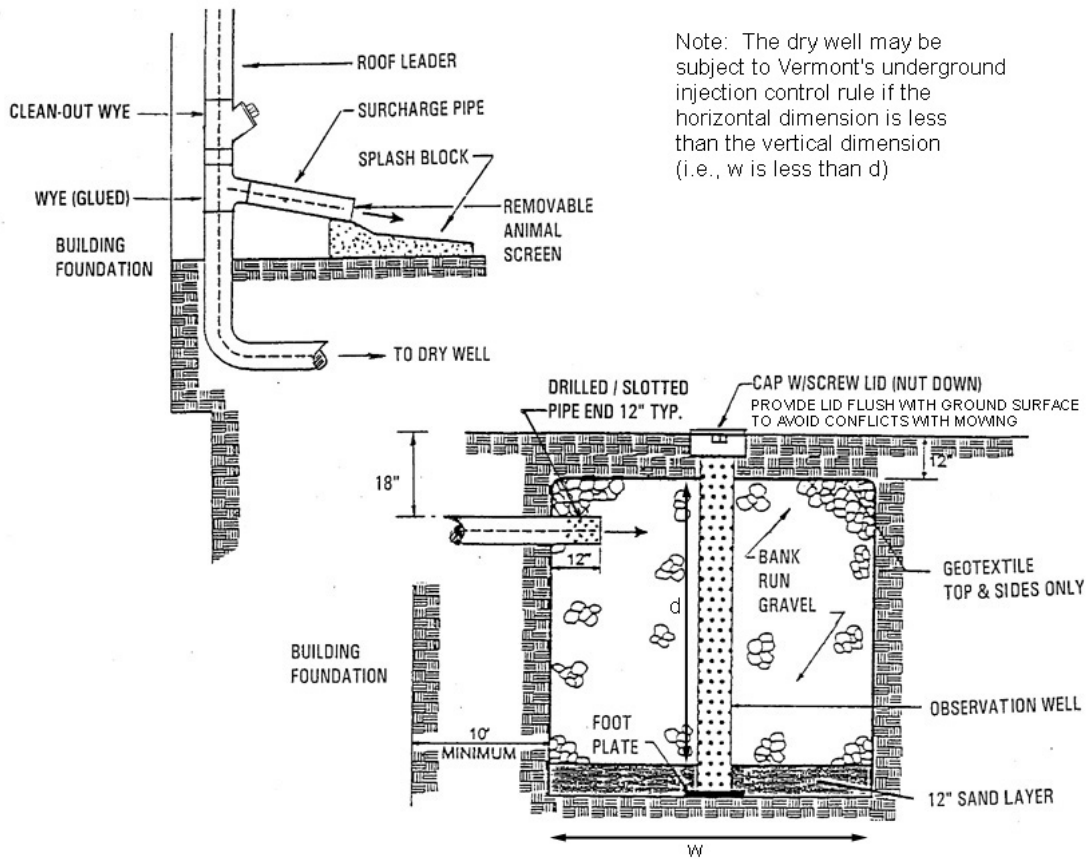

Figure 3.1 Schematic of Dry Well (Source: adapted after Howard County, MD)

Rooftop Disconnection Credit Example Application

Base Data

Site Data: 108 Single Family Residential Lots (~ 1/2 acre lots)
 Site Area = 45.1 ac
 Original Impervious Area = 12.0 ac; or $I = 12.0/45.1 = 26.6\%$
 Site Soils Types: 78% "C", 22% "D"
 Composite Recharge Factor, $F = 0.08$
 Original $Re_v = 0.08$ acre-feet; $Re_a = 0.96$ acres
 Original $R_v = 0.29$
 Original $WQ_v = 0.98$ acre-feet

Rooftop Credit (see Figure 3.2)

42 houses disconnected
 Average house area = 2,500 ft²
 Net impervious area reduction = $(42)(2,500 \text{ ft}^2) / (43,560 \text{ ft}^2/\text{ac}) = 2.41$ acres
 New impervious area = $12.0 - 2.41 = 9.59$ acres; or $I = 9.59/45.1 = 21.3\%$

Required recharge (Re_a) is 0.96 acres and 2.41 acres were disconnected thereby meeting 100% of the recharge requirement.

New $R_v = 0.05 + .009(21.3) = 0.24$

New $WQ_v = (P)(R_v)(A)/12 = 0.9" (0.24)(45.1)/12 = 0.81$ acre-feet; or a 0.17 acre-feet reduction

Percent Reductions Using Rooftop Disconnection Credit:

- $Re_v = 100\%$
- $WQ_v = (0.98 - 0.81) / 0.98 = 17.4\%$

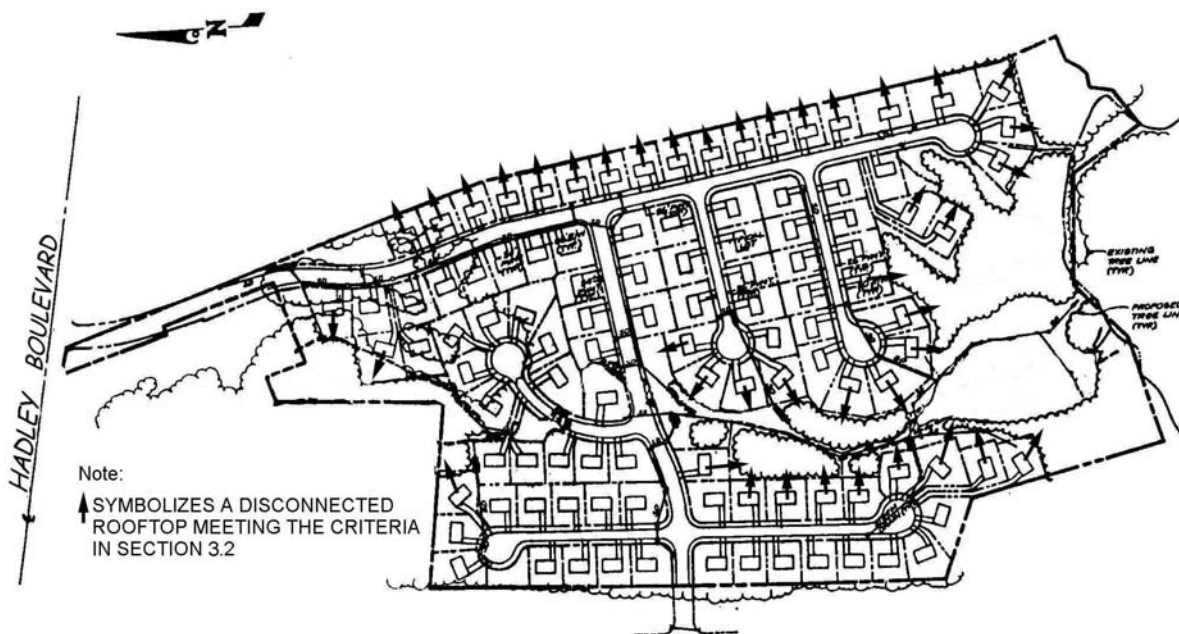

Figure 3.2 Schematic of Rooftop Disconnection Credit

3.3 Disconnection of Non-Rooftop Runoff Credit

Credit is given for practices that disconnect surface impervious cover runoff by directing it to pervious areas where it is either infiltrated into the soil or filtered (by overland flow). This credit can be obtained by grading the site to promote overland vegetative filtering.

These "disconnected" areas can be subtracted from the site impervious area when computing WQ_v . In addition, disconnected surface impervious cover can be used to meet the Re_v requirement as a non-structural practice under the Percent Area Method.

Restrictions on the Credit

The credit is subject to the following restrictions:

- The maximum contributing impervious flow path length shall be 75 feet.
- Runoff cannot come from a designated hotspot land use.
- The length of the "disconnection" must be equal to or greater than the contributing length.
- The entire vegetative "disconnection" shall be on a slope less than or equal to 5.0%.
- The surface impervious area to any one-discharge location cannot exceed 1,000 ft².
- Disconnections are encouraged on relatively permeable soils (HSGs A and B); therefore, no soil evaluation is required.
- In less permeable soils (HSGs C and D), the water table depth and permeability shall be evaluated by a professional engineer to determine if a spreading device such as a french drain, gravel trench or other temporary storage device is needed to compensate for poor infiltration capability.
- For those areas draining directly to a buffer, only the non-rooftop disconnection credit or the stream buffer credit can be used, not both.

See Section 3.8 for an example application of this credit draining to a filter strip.

3.4 Stream Buffer Credit

This credit is given when a stream buffer effectively treats stormwater runoff. Effective treatment constitutes capturing runoff from pervious and impervious areas adjacent to a stream buffer and treating runoff through the overland flow in a natural buffer. The use of a filter strip is also recommended to treat overland flow in the green space of a development site (see Figure 3.3). The credits include:

- The area draining by sheet flow to a stream buffer is subtracted from total site area in the WQ_v calculation.
- The impervious area draining to stream buffer contributes to the recharge requirement, (Re_v) , under the Percent Area Method.

Restrictions on the Credit

The credit is subject to the following conditions:

- The minimum stream buffer width (i.e., perpendicular to the stream flow path) shall be 50 feet as measured from the bank elevation of a stream, the boundary of a Class 1 or 2 wetland, or the top of bank of an existing dormant channel in a braided channel system.
- The maximum contributing path shall be 150 feet for pervious surfaces and 75 feet for impervious surfaces.
- The average contributing overland slope to and across the stream buffer shall be less than or equal to 5.0%.
- Runoff shall enter the stream buffer as sheet flow. A level spreading device shall be utilized where local site conditions prevent sheet flow from being maintained.
- The credit is not applicable if rooftop or non-rooftop disconnection is already provided (i.e., no double counting).
- Stream buffers shall remain ungraded and uncompacted, and the over-story and under-story vegetation shall be maintained in a natural condition.

See Section 3.8 for an example application of this credit.

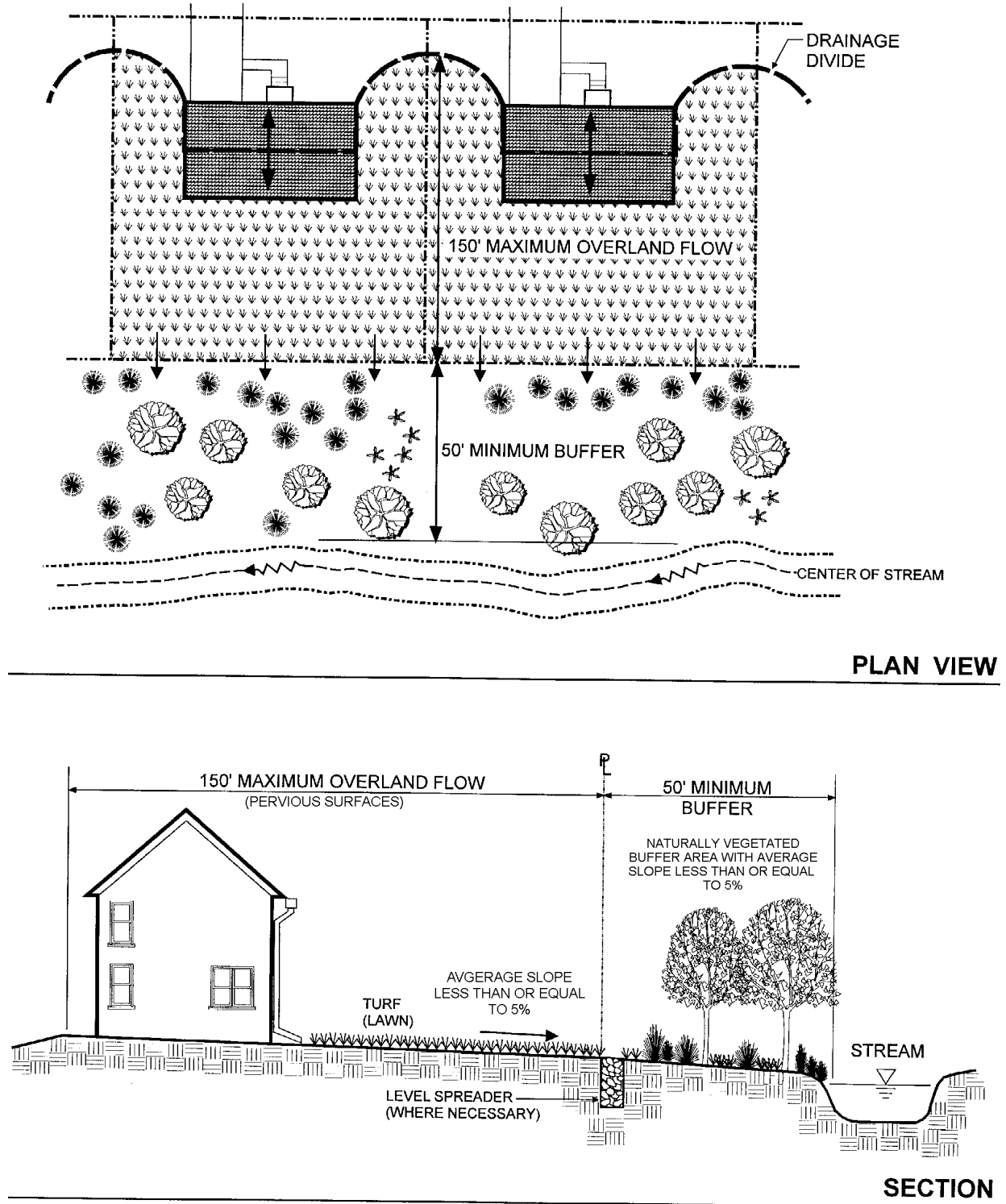

Figure 3.3 Example of Stream Buffer Credit Option

3.5 Grass Channel Credit

Credit may be given when open grass channels are used to reduce the volume of runoff and pollutants during smaller storms (i.e., 0.9 inches and less).

If designed according to the following design criteria, the grass channel will meet the WQ_v for certain kinds of residential development. Use of a grass channel will also meet the minimum recharge Re_v requirement (under the Percent Area Method) regardless of the geometry or slope, provided that the remaining criteria related to land use and channel length are met.

CNs for channel protection or peak flow control (CP_v or Q_p) will not change.

Grass Channel Design Criteria

The credit is obtained if a grass channel meets the following criteria.

- Land use is moderate to low density residential (maximum density of 4 du/ac).
- The bottom width shall be 2 foot minimum and 8 foot maximum.
- The side slopes shall be 3H:1V or flatter.
- The channel slope shall be less than or equal to 4.0%.
- The length of the grass channel shall be equal to the roadway length.

Note: The grass channel (O-3) is an acceptable STP that can be applied to other land uses with the important provision that the flow velocity of 1 fps and the average residence time of 10 minutes is maintained for the 0.9" rainfall event. Designers do not need to calculate these parameters to receive the credit using the above criteria (it is presumed that these design parameters are met because of the density, channel geometry, and slope limitations required to obtain the credit).

Grass Channel Credit Example Application

Base Data

Site Data: 108 Single Family Residential Lots (~ ½ acre lots)

Site Area = 45.1 acres

Original Impervious Area = 12.0 acres; or $I = 12.0/45.1 = 26.6\%$

Site Soils Types: 78% "C", 22% "D"

Composite F = 0.08

Original $Re_v = 0.08$ acre-feet; $Re_a = 0.96$ acres

Original $R_v = 0.29$

Original $WQ_v = 0.98$ acre-feet

Grass Channel Credit (see Figure 3.4)

Entire site is open section road, but only 11.2 acres meet the WQ_v requirement design criteria for the grass channel credit (i.e., 3:1 sideslopes, 2 foot bottom width and slope less than or equal to 4%).

Required recharge (Re_a) is 0.96 acres and the full site is drained by grass channels, thereby meeting 100% of the recharge requirement.

New WQ_v Area = $(45.1 - 11.2) = 33.9$ acres

New $WQ_v = (P)(R_v)(A)/12 = 0.9'' (0.29)(33.9)/12 = 0.74$ acre-feet; or a 0.24 acre-feet reduction

Percent Reductions Using Grass Channel Credit:

- $Re_v = 100\%$
- $WQ_v = (0.98 - 0.74) / 0.98 = 24.5\%$

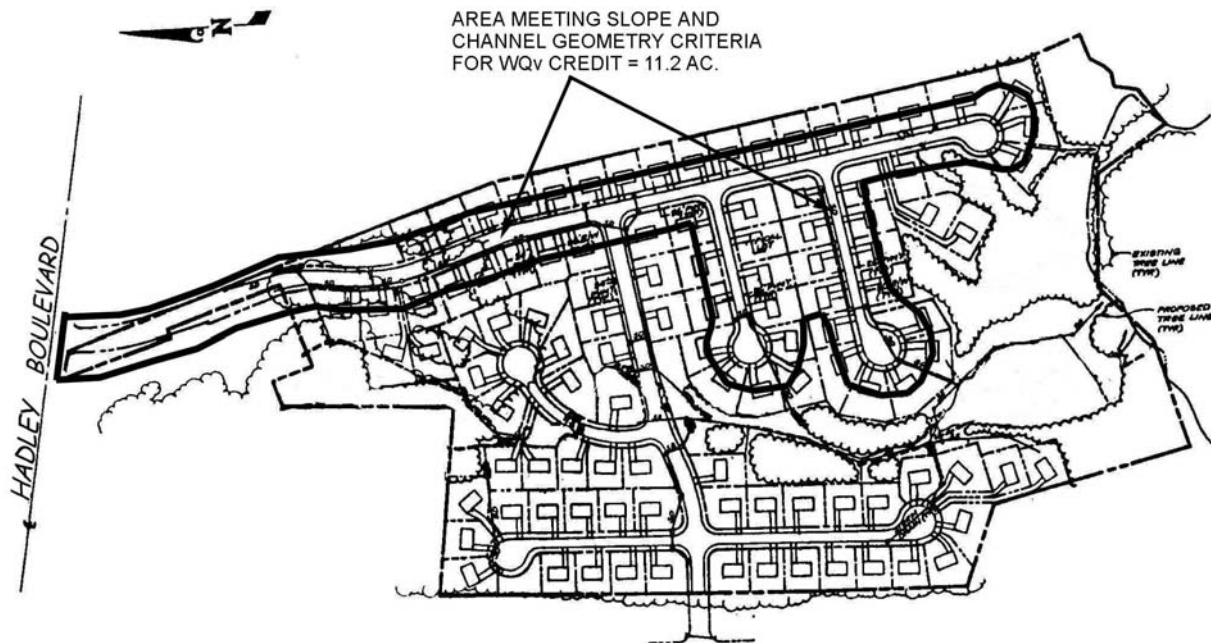

Figure 3.4 Schematic of Grass Channel Credit

3.6 Environmentally Sensitive Rural Development Credit

This credit is given when a group of environmental site design techniques are applied to lower density or rural residential development. The credit eliminates the need for structural practices to treat both the Re_v and WQ_v and can reduce required volumes for CP_v and Q_p .

Minimum Criteria for Credit

The Re_v and WQ_v requirements are completely met without the use of structural practices in certain low density (a maximum of 1 unit per 2 acres as an average over the total project area) residential developments when the following conditions are met:

- The total impervious cover footprint is less than 8 % of lot and project area.
- A minimum of 25% of the project is protected in natural conservation areas.
- Rooftop runoff is disconnected in accordance with the criteria outlined under Credit 2 (Section 3.2).
- Grass channels are used to convey runoff versus curb and gutter for roads and/or driveways (with no specific constraints on water quality volume, velocity or minimum retention time).
- Stream buffers are incorporated into the site design on both perennial and intermittent streams (where applicable).

The designer must still address applicable stormwater detention for all roadway and connected impervious surfaces (i.e., CP_v , Q_{p10} , and Q_{p100}).

Environmentally Sensitive Rural Development Credit Example Application

Base Data

Site Data: a single family lot that is part of an 8 acre low density subdivision

Lot Area = 2.5 acres

Conservation Area = 0.65 acres

Impervious Area = .20 ac = 8%

Site Soils Types: 100% "B"

F = 0.25

Original WQ_v = minimum WQ_v of 0.2 inches is required = $0.2'' (2.5) (43,560/12) = 1,815 \text{ ft}^3$

Original Re_v = $(2.5) (0.08) (.25) (43,560/12) = 182 \text{ ft}^3$

Environmentally Sensitive Rural Credit (see Figure 3.5)

Required recharge is considered met by site design.

Required water quality volume is considered met by site design.

CP_v and Q_p : No change in CN, t_c may be longer which would reduce Q_p requirements

Percent Reductions Using Environmentally Sensitive Rural Credit:

- $Re_v = 100\%$
- $WQ_v = 100\%$

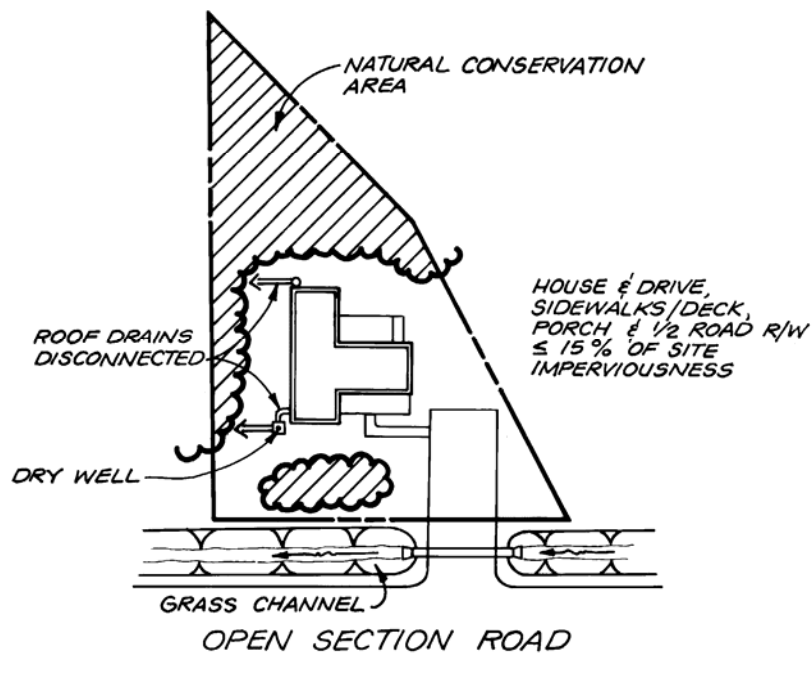

Figure 3.5 Schematic of Environmentally Sensitive Rural Development Credit

3.7 Dealing with Multiple Credits

Site designers are encouraged to utilize as many credits as they can on a site. Greater reductions in stormwater storage volumes can be achieved when many credits are combined together (e.g. disconnecting rooftops and protecting natural conservation areas). However, with the exception of a disconnected area draining to a conservation area, credits cannot be claimed twice for an identical area of the site (e.g. claiming credit for stream buffers and disconnecting rooftops over the same site area).

3.8 Other Strategies to Reduce Impervious Cover

Site planning practices that reduce the creation of impervious area in new residential and commercial developments and therefore reduce the WQ_v for the site should be encouraged whenever feasible¹⁴. Examples of progressive site design practices that minimize the creation of impervious cover include:

- Narrower residential road sections
- Shorter road lengths
- Smaller turnarounds and cul-de-sac radii
- Permeable spill-over parking areas (these areas should be valued as 50% impervious, unless designed specifically for infiltration)
- Smaller parking demand ratios
- Smaller parking stalls
- Angled one way parking
- Cluster subdivisions
- Smaller front yard setbacks
- Shared parking and driveways
- Narrower sidewalks

Where these techniques are employed, it may be possible to reduce stormwater storage volumes. For example, since the WQ_v is directly based on impervious cover, a reduction in impervious cover reduces WQ_v . For CP_v and Q_p , the designer can compute curve numbers (CN) based on the actual measured impervious area at a site using the following equation (adopted from TR-55, 1986):

$$(98) I + (CN) P = CN$$

where: I = percent impervious area at the site
 P = percent pervious area at the site
 CN = curve number for the appropriate pervious cover

Figures 3.6 and 3.7 show an example of a retail site designed as a conventional development, and as a site planned using improved site design practices and techniques, respectively. Some of the

¹⁴ The reader is referred to the following two references for a more detailed presentation of better site design and low impact development: 1) Center for Watershed Protection. 1998. *Better Site Design A Handbook for Changing Development Rules in Your Community*. Ellicott City, MD; and 2) Prince George's County MD Dept. of Environmental Resources. 1999. *Low Impact Development Design Strategies: An Integrated Design Approach*. Largo, MD.

noteworthy features of the innovative site plan include: preservation of some forested areas, stream buffer, reduced parking ratios, compact and pervious overflow parking spaces, and use of vegetated stormwater practices such as filter strips and bioretention areas.

Though not all land use types and developments are amenable to every approach described here, there are more opportunities for flexibility and creativity in site design than many realize. Redevelopment sites also can utilize several of these practices and techniques in the redesign of an area.

The following example (using Figures 3.6 and 3.7) quantifies the water quality and recharge requirement reductions that can be realized by implementing several of these practices and design techniques.

Base Data (see Figure 3.6)

Site Area = 9.3 ac

Original Impervious Area = 6.5 ac; or $I = 6.5/9.3 = 69.9\%$

Site Soils Types: 50% "B", 50% "C," split evenly over the impervious area

Composite $F = [0.25 (6.5/2) + 0.10 (6.5/2)]/6.5 = 0.18$

Original $Re_v = 0.18 (6.5)/12 = 0.10$ acre-feet

Original $R_v = 0.05 + .009(69.9) = 0.68$

Original $WQ_v = 0.9'(0.68)(9.3 \text{ ac})/12 = 0.47$ acre-feet

Site Planning Strategies (see Figure 3.7)

The revised site incorporates the following features:

- 1.8 acres preserved in a conservation easement (natural area conservation credit).
- 0.46 acres of parking lot drain to a buffer with an overland flow path less than 75 feet (stream buffer credit).
- 0.28 acres of parking lot/loading area drain to a filter strip with an overland flow path less than 75 feet (disconnection of non-rooftop runoff credit).
- The total site impervious area was reduced from 6.5 acres to 5.8 acres by the site design revision; the new site $I = 5.8/9.3 = 62.4\%$.

The new storage requirements for Re_v :

- New composite $F = [0.25 (5.8 \text{ ac}/2) + 0.10 (5.8 \text{ ac}/2)]/5.8 = 0.18$
- New Re_v (Percent Volume Method) = $0.18 (5.8 \text{ ac})/12 = 0.09$ acre-feet
- New Re_a (Percent Area Method) = $FAI = 0.18 (9.3 \text{ ac})(.624) = 1.04$ acres
- Using the Percent Area Method and noting that 0.46 acres drain to the buffer and 0.28 acres drain to a filter strip, then $Re_a = 1.04 \text{ ac} - (0.46 \text{ ac} + 0.28 \text{ ac}) = 0.3$ acres
- Therefore, the remaining $Re_v = (0.3 \text{ ac}/1.04 \text{ ac}) (0.09 \text{ ac-ft}) = 0.02$ acre-feet

0.02 acre-feet must be managed by an approved "structural" practice, see Section 2.

The new storage requirements for WQ_v :

- New Impervious Area (to take credit for non-rooftop disconnection credits) = $5.8 \text{ ac} - 0.28 \text{ ac} = 5.52 \text{ acres}$; or $5.52/9.3 = 59.4\%$
- New $R_v = 0.05 + .009(59.4) = 0.58$
- New WQ_v Area (to take credit for natural area conservation and buffer) = $9.3 \text{ ac} - (1.8 \text{ ac} + 0.46 \text{ ac}) = 7.04 \text{ acres}$
- New $WQ_v = (P)(R_v)(A)/12 = 0.9'' (0.58)(7.04 \text{ ac})/12 = 0.31 \text{ acre-feet}$; or a 0.16 acre-feet reduction

Percent Reductions Using Site Planning Strategies:

- $Re_v = (0.10 - 0.02) / 0.10 = 80.0\%$
- $WQ_v = (0.47 - 0.31) / 0.47 = 34.0\%$

Also, with a 0.5-acre net reduction in site imperviousness, the CN for computing the CP_v and Q_p will be lower, thereby reducing the storage requirements for these storms by a modest amount.

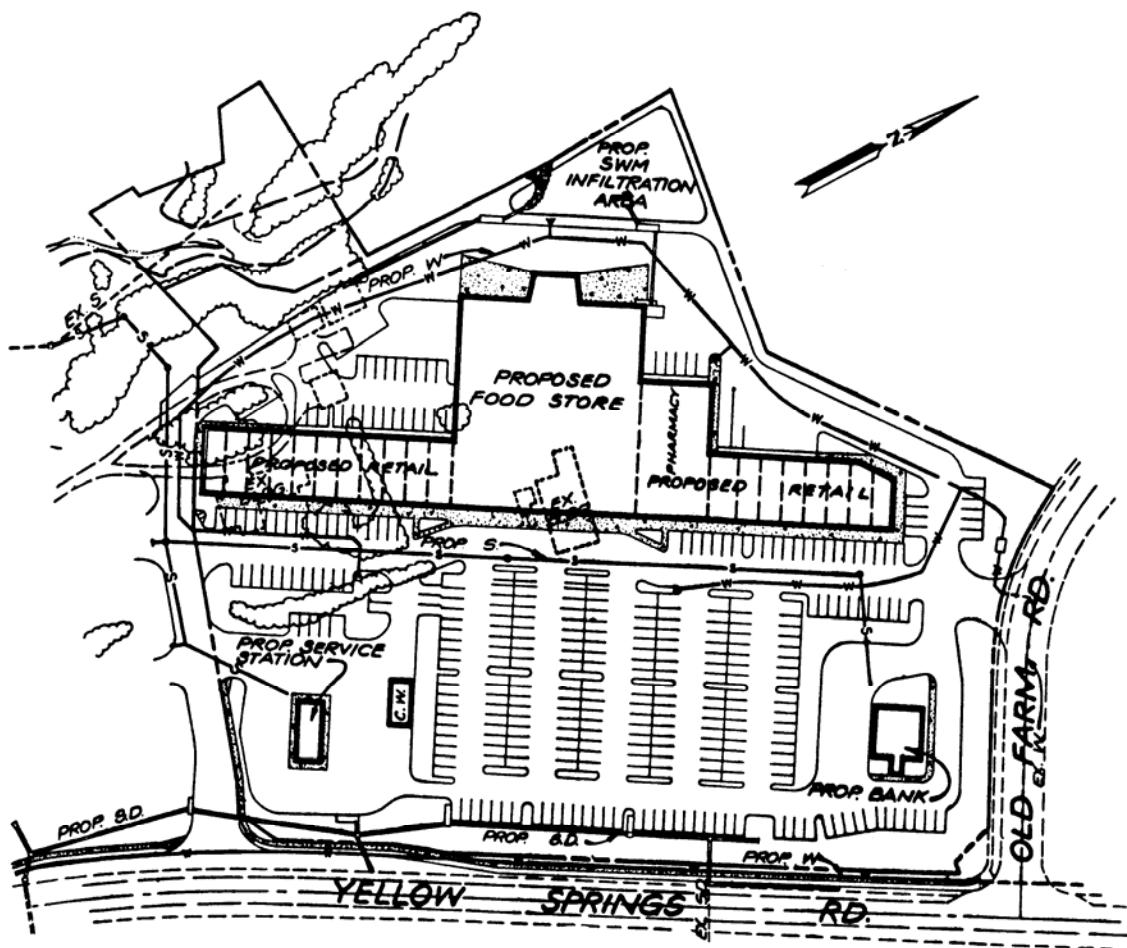

Figure 3.6 Example of Conventional Retail Site Design

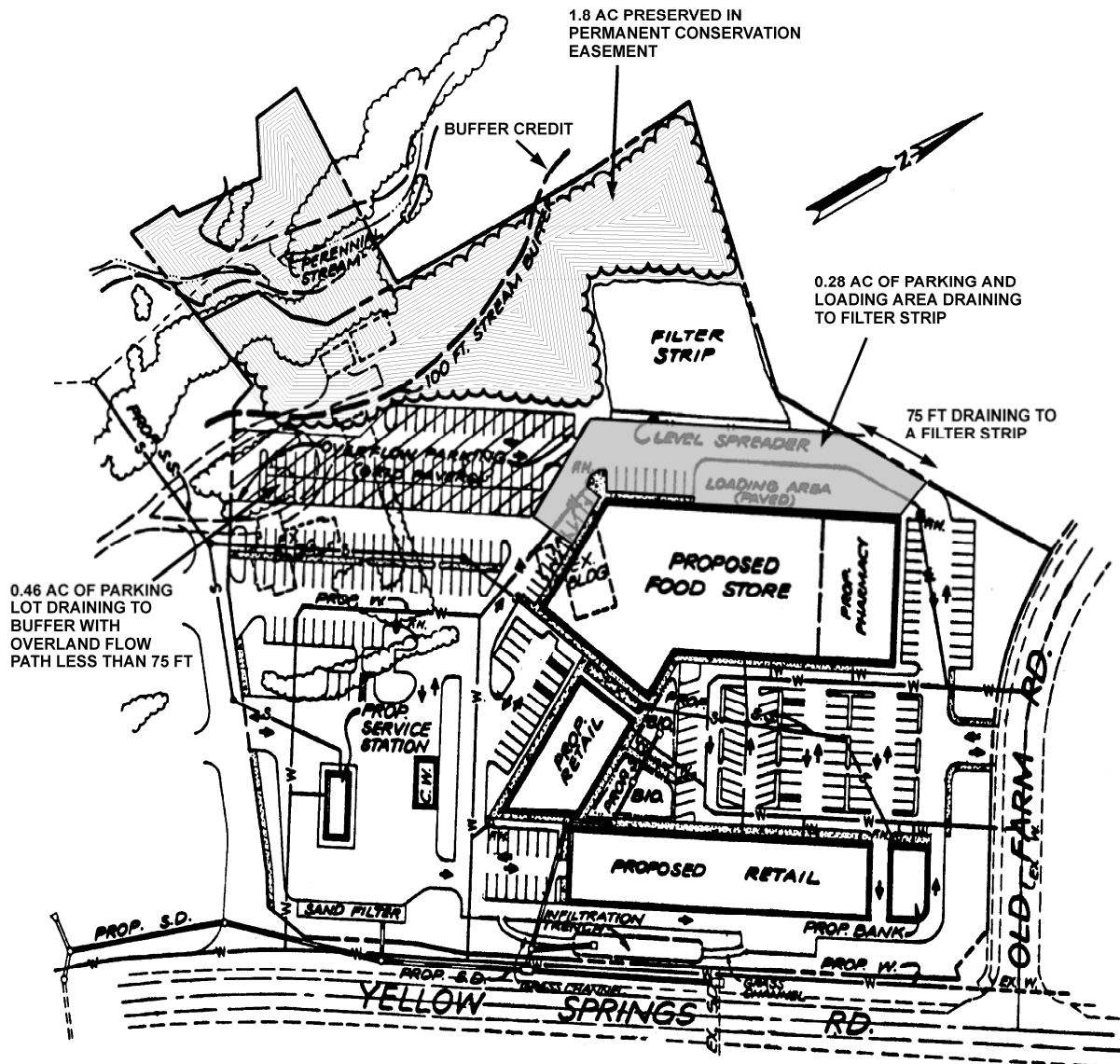

Figure 3.7 Example of Modified Retail Site Design

GLOSSARY

AGENCY - The Vermont Agency of Natural Resources.

ANTI-SEEP COLLAR - An impermeable diaphragm usually of sheet metal or concrete constructed at intervals within the zone of saturation along the conduit of a principal spillway to increase the seepage length along the conduit and thereby prevent piping or seepage along the conduit.

ANTI-VORTEX DEVICE - A device designed and placed on the top of a riser or at the entrance of a pipe to prevent the formation of a vortex in the water at the entrance.

APPLICANT - A person applying for permit coverage. In some cases, more than one person may apply as co-applicants.

AQUATIC BENCH - A ten to fifteen foot wide bench which is located around the inside perimeter of a permanent pool and is normally vegetated with aquatic plants; the goal is to provide pollutant removal and enhance safety in areas using stormwater ponds.

AQUIFER - A geological formation that contains and transports groundwater.

AS-BUILT - Drawing or certification of conditions as they were actually constructed.

AUTHORIZATION TO DISCHARGE - An authorization to discharge issued by the Secretary pursuant to a general permit.

BAFFLES - Guides, grids, grating or similar devices placed in a pond to deflect or regulate flow and create a longer flow path.

BANKFULL FLOW - The condition where streamflow just fills a stream channel up to the top of the bank and at a point where the water begins to overflow onto a floodplain.

BARREL - The closed conduit used to convey water under or through an embankment: part of the principal spillway.

BASE FLOW - The stream discharge from ground water.

BERM - A shelf that breaks the continuity of a slope; a linear embankment or dike.

BEST MANAGEMENT PRACTICE or BMP - A schedule of activities, prohibitions of practices, maintenance procedures, and other management practices to prevent or reduce water pollution, including but not limited to the stormwater treatment practices (STPs) set forth in this Manual.

BIORETENTION - A water quality practice that utilizes landscaping and soils to treat urban stormwater runoff by collecting it in shallow depressions, before filtering through a fabricated planting soil media.

CHANNEL - A natural stream that conveys water; a ditch or swale excavated for the flow of water.

CHANNEL STABILIZATION - Erosion prevention and stabilization of velocity distribution in a channel using jetties, drops, revetments, structural linings, vegetation and other measures.

CHECK DAM - A small dam construction (i.e., vertical drop of 6 to 12 inches) in a gully, swale, or other small watercourse to decrease the stream flow velocity (by reducing the channel gradient), minimize channel scour, and promote deposition of sediment. Check dams can be constructed of wood, small diameter stone, concrete, or earth.

CHUTE - A high velocity, open channel for conveying water to a lower level without erosion.

CLAY (SOILS) - 1. A mineral soil separate consisting of particles less than 0.002 millimeter in equivalent diameter. 2. A soil texture class. 3. (Engineering) A fine-grained soil (more than 50 percent passing the No. 200 sieve) that has a high plasticity index in relation to the liquid limit. (Unified Soil Classification System)

CLEAN WATER ACT - The federal Clean Water Act, 33 U.S.C.A. §1251 et. seq.

COCONUT ROLLS - Also known as coir rolls, these are rolls of natural coconut fiber designed for use in streambank stabilization.

COMPACTION (SOILS) - Any process by which the soil grains are rearranged to decrease void space and bring them in closer contact with one another, thereby increasing the weight of solid material per unit of volume, increasing the shear and bearing strength and reducing permeability.

CONDUIT - Any channel intended for the conveyance of water, whether open or closed.

CONTOUR - 1. An imaginary line on the surface of the earth connecting points of the same elevation. 2. A line drawn on a map connecting points of the same elevation.

CORE TRENCH - A trench, filled with relatively impervious material intended to reduce seepage of water through porous strata.

CRADLE - A structure usually of concrete shaped to fit around the bottom and sides of a conduit to support the conduit, increase its strength and in dams, to fill all voids between the underside of the conduit and the soil.

CREST - 1. The top of a dam, dike, spillway or weir, frequently restricted to the overflow portion. 2. The summit of a wave or peak of a flood.

CRUSHED STONE - Aggregate consisting of angular particles produced by mechanically crushing rock.

CURVE NUMBER (CN) - A numerical representation of a given area's hydrologic soil group, plant cover, impervious cover, interception and surface storage derived in accordance with Natural Resources Conservation Service methods. This number is used to convert rainfall volume into runoff volume.

CUT - Portion of land surface or area from which earth has been removed or will be removed by excavation; the depth below original ground surface to excavated surface.

CUT-AND-FILL - Process of earth moving by excavating part of an area and using the excavated material for adjacent embankments or fill areas.

CUTOFF - A wall or other structure, such as a trench, filled with relatively impervious material intended to reduce seepage of water through porous strata.

DAM - A barrier to confine or raise water for storage or diversion, to create a hydraulic head, to prevent gully erosion, or for retention of soil, sediment or other debris.

DETENTION - The temporary storage of storm runoff in a STP with the goals of controlling peak discharge rates and providing gravity settling of pollutants.

DETENTION STRUCTURE - A structure constructed for the purpose of temporary storage of stream flow or surface runoff and gradual release of stored water at controlled rates.

DEVELOPMENT - The construction of impervious surface(s) on a tract or tracts of land.

DIKE - An embankment to confine or control water, for example, one built along the banks of a river to prevent overflow or lowlands; a levee.

DISTRIBUTED RUNOFF CONTROL (DRC) - A stream channel protection criteria which utilizes a non-uniform distribution of the storage stage-discharge relationship within a STP to minimize the change in channel erosion potential from predeveloped to developed conditions.

DISTURBANCE – Removal of stable surface treatment leaving exposed soil susceptible to erosion.

DISTURBED AREA - An area in which the natural vegetative soil cover has been removed or altered and, therefore, is susceptible to erosion.

DIVERSION - A channel with a supporting ridge on the lower side constructed across the slope to divert water from areas where it is in excess to sites where it can be used or disposed of safely. Diversions differ from terraces in that they are individually designed.

DRAINAGE - 1. The removal of excess surface water or ground water from land by means of surface or subsurface drains. 2. Soils characteristics that affect natural drainage.

DRAINAGE AREA (WATERSHED) - All land and water area from which runoff may run to a common (design) point.

DROP STRUCTURE - A structure for dropping water to a lower level and dissipating surplus energy; a fall. The drop may be vertical or inclined.

DRY SWALE - An open drainage channel explicitly designed to detain and promote the filtration of stormwater runoff through an underlying fabricated soil media.

EMERGENCY SPILLWAY - A dam spillway designed and constructed to discharge flow in excess of the principal spillway design discharge.

ENERGY DISSIPATOR - A designed device such as an apron of rip-rap or a concrete structure placed at the end of a water transmitting apparatus such as pipe, paved ditch or paved chute for the purpose of reducing the velocity, energy and turbulence of the discharged water.

EROSION - 1. The wearing away of the land surface by running water, wind, ice, or other geological agents, including such processes as gravitational creep. 2. Detachment and movement of soil or rock fragments by water, wind, ice or gravity. The following terms are used to describe different types of water erosion:

Accelerated erosion - Erosion much more rapid than normal, natural or geologic erosion, primarily as a result of the influence of the activities of man or, in some cases, of other animals or natural catastrophes that expose base surfaces, for example, fires.

Gully erosion - The erosion process whereby water accumulates in narrow channels and, over short periods, removes the soil from this narrow area to considerable depths, ranging from 1 or 2 feet to as much as 75 to 100 feet.

Rill erosion - An erosion process in which numerous small channels only several inches deep are formed. See rill.

Sheet erosion - The spattering of small soil particles caused by the impact of raindrops on wet soils. The loosened and spattered particles may or may not subsequently be removed by surface runoff.

EROSIVE VELOCITIES - Velocities of water that are high enough to wear away the land surface. Exposed soil will generally erode faster than stabilized soils. Erosive velocities will vary according to the soil type, slope, structural, or vegetative stabilization used to protect the soil.

EXFILTRATION - The downward movement of water through the soil; the downward flow of runoff from the bottom of an infiltration STP into the soil. Where native soil conditions have adequate permeability, sedimentation chambers associated with filters can be designed to exfiltrate by having open or exposed bottoms. Similarly, bioretention facilities can be designed to exfiltrate by foregoing a perforated underdrain manifold.

EXISTING IMPERVIOUS SURFACE - An impervious surface that is in existence, regardless of whether it ever required a stormwater discharge permit.

EXISTING STORMWATER DISCHARGE - A discharge of regulated stormwater runoff which first occurred prior to June 1, 2002 and that is subject to the permitting requirements of 10 V.S.A. Chapter 47.

EXPANSION AND EXPANDED PORTION OF AN EXISTING DISCHARGE - An increase or addition of new impervious surface to an existing impervious surface, such that the total resulting impervious surface is greater than the minimum regulatory threshold.

EXTENDED DETENTION (ED) - A stormwater design feature that provides for the gradual release of a volume of water over a 12 to 24 hour interval in order to increase settling of urban pollutants and protect downstream channels from frequent storm events.

EXTREME FLOOD (Q_f) - The storage volume required to control those infrequent but large storm events in which overbank flows approach the floodplain boundaries of the 100-year flood.

FILTER BED - The section of a constructed filtration device that houses the filter media and the outflow piping.

FILTER FENCE - A geotextile fabric designed to trap sediment and filter runoff.

FILTER MEDIA - The sand, soil, or other organic material in a filtration device used to provide a permeable surface for pollutant and sediment removal.

FILTER STRIP - A strip of permanent vegetation above ponds, diversions and other structures to retard flow of runoff water, causing deposition of transported material, thereby reducing sediment flow.

FINES (SOIL) - Generally refers to the silt and clay size particles in soil.

FLOODPLAIN - Areas adjacent to a stream or river that are subject to flooding or inundation during a storm event that occurs, on average, once every 100 years (or has a likelihood of occurrence of 1/100 in any given year).

FLOW SPLITTER - An engineered, hydraulic structure designed to divert a percentage of storm flow to a STP located out of the primary channel, or to direct stormwater to a parallel pipe system, or to bypass a portion of baseflow around a STP.

FOREBAY - Storage space located near a stormwater STP inlet that serves to trap incoming coarse sediments before they accumulate in the main treatment area.

FREEBOARD (HYDRAULICS) - The distance between the maximum water surface elevation anticipated in design and the top of retaining banks or structures. Freeboard is provided to prevent overtopping due to unforeseen conditions.

FRENCH DRAIN - A type of drain consisting of an excavated trench refilled with pervious material, such as coarse sand, gravel or crushed stone, through whose voids water percolates and flows to an outlet.

GABION - A flexible woven-wire basket composed of two to six rectangular cells filled with small stones. Gabions may be assembled into many types of structures such as revetments, retaining walls, channel liners, drop structures and groins.

GABION MATTRESS - A thin gabion, usually six or nine inches thick, used to line channels for erosion control.

GRADE - 1. The slope of a road, channel or natural ground. 2. The finished surface of a canal bed, roadbed, top of embankment, or bottom of excavation; any surface prepared for the support of construction, like paving or laying a conduit. 3. To finish the surface of a canal bed, roadbed, top of embankment or bottom of excavation.

GRASS CHANNEL - An open vegetated channel used to convey runoff and to provide treatment by filtering out pollutants and sediments.

GRAVEL - 1. Aggregate consisting of mixed sizes of 1/4 inch to 3-inch particles that normally occur in or near old streambeds and have been worn smooth by the action of water. 2. A soil having particle sizes, according to the Unified Soil Classification System, ranging from the No. 4 sieve size angular in shape as produced by mechanical crushing.

GRAVEL DIAPHRAGM - A stone trench filled with small, river-run gravel used as pretreatment and inflow regulation in stormwater filtering systems.

GRAVEL FILTER - Washed and graded sand and gravel aggregate placed around a drain or well screen to prevent the movement of fine materials from the aquifer into the drain or well.

GRAVEL TRENCH - A shallow excavated channel backfilled with gravel and designed to provide temporary storage and permit percolation of runoff into the soil substrate.

GROUND COVER - Plants that are low growing and provide a thick growth that protects the soil as well as providing some beautification of the area occupied.

GULLY - A channel or miniature valley cut by concentrated runoff through which water commonly flows only during and immediately after heavy rains or during the melting of snow. The distinction between gully and rill is one of depth. A gully is sufficiently deep that it would not be obliterated by normal tillage operations, whereas a rill is of lesser depth and would be smoothed by ordinary farm tillage.

HEAD (HYDRAULICS) - 1. The height of water above any plane of reference. 2. The energy, either kinetic or potential, possessed by each unit weight of a liquid expressed as the vertical height through which a unit weight would have to fall to release the average energy possessed. Used in various terms such as pressure head, velocity head, and head loss.

HERBACEOUS PERENNIAL (PLANTS) - A plant whose stems die back to the ground each year.

HIGH MARSH - A pondscaping zone within a stormwater wetland that exists from the surface of the normal pool to a six-inch depth and typically contains the greatest density and diversity of emergent wetland plants.

HIGH MARSH WEDGES - Slices of shallow wetland (less than or equal to 6 inches) dividing a stormwater wetland.

HOT SPOT - Area where land use or activities generate highly contaminated runoff, with concentrations of pollutants in excess of those typically found in stormwater.

HYDRAULIC GRADIENT - The slope of the hydraulic grade line. The slope of the free surface of water flowing in an open channel.

HYPOXIA - Lack of oxygen in a waterbody resulting from eutrophication.

HYDROGRAPH - A graph showing variation in stage (depth) or discharge of a stream of water over a period of time.

HYDROLOGIC SOIL GROUP (HSG) - A Natural Resource Conservation Service classification system in which soils are categorized into four runoff potential groups. The groups range from A soils, with high permeability and little runoff production, to D soils, which have low permeability rates and produce much more runoff.

HYDROSEED - Seed or other material applied to areas in order to revegetate after a disturbance.

IMPERVIOUS SURFACE (I) - Those manmade surfaces, including, but not limited to, paved and unpaved roads, parking areas, roofs, driveways, and walkways, from which precipitation runs off rather than infiltrates.

INDUSTRIAL MULTI-SECTOR STORMWATER PERMIT - An individual or general NPDES permit issued to a commercial industry or group of industries that regulates the pollutant levels associated with industrial storm water discharges or specifies on-site pollution control strategies.

INFILTRATION RATE (f_c) - The rate at which stormwater percolates into the subsoil measured in inches per hour.

INFLOW PROTECTION - A water-handling device used to protect the transition area between any water conveyance (dike, swale, or swale dike) and a sediment-trapping device.

LEVEL SPREADER - A device for distributing stormwater uniformly over the ground surface as sheet flow to prevent concentrated, erosive flows and promote infiltration.

MANNING'S FORMULA (HYDRAULICS) - A formula used to predict the velocity of water flow in an open channel or pipeline:

$$V = (1.486/n) R^{2/3} S^{1/2}$$

Where V is the mean velocity of flow in feet per second; R is the hydraulic radius; S is the slope of the energy gradient or for assumed uniform flow the slope of the channel, in feet per foot; and n is the roughness coefficient or retardance factor of the channel lining.

MICROPOOL - A smaller permanent pool that is incorporated into the design of larger stormwater ponds to avoid resuspension or settling of particles and minimize impacts to adjacent natural features.

MICROTOPOGRAPHY - The complex contours along the bottom of a shallow marsh system, providing greater depth variation, which increases the wetland plant diversity and increases the surface area to volume ratio of a stormwater wetland.

MULCH - Covering on surface of soil to protect and enhance certain characteristics, such as water retention qualities.

MUNICIPALITY - An incorporated city, town, village or gore, a fire district established pursuant to state law, or any other duly authorized political subdivision of the state.

NPDES - Acronym for the National Pollutant Discharge Elimination System, for the issuance of permits under section 402 of the federal Clean Water Act and includes the Vermont-administered NPDES program authorized by the federal Environmental Protection Agency.

NEW DEVELOPMENT - The construction of new impervious surface on a tract or tracts of land where no impervious surface previously existed.

NEW IMPERVIOUS SURFACE – An impervious surface created after the effective date of this Rule.

NEW STORMWATER DISCHARGE – A new or expanded discharge of regulated stormwater runoff, subject to the permitting requirements of 10 V.S.A. Chapter 47, which first occurs after June 1, 2002 and has not been previously authorized pursuant to 10 V.S.A. Chapter 47.

NITROGEN-FIXING (BACTERIA) - Bacteria having the ability to fix atmospheric nitrogen, making it available for use by plants. Inoculation of legume seeds is one way to insure a source of these bacteria for specified legumes.

NORMAL DEPTH - Depth of flow in an open conduit during uniform flow for the given conditions.

OUTFALL - The point where water flows from a conduit, stream, or drain.

OFF-LINE - A stormwater management system designed to manage a storm event by diverting a percentage of stormwater events from a stream or storm drainage system.

OFF-SITE - Land within a project's drainage area that is not characterized as being part of the site.

ON-LINE - A stormwater management system designed to manage stormwater in its original stream or drainage channel.

OFFSET OR OFFSET PROJECT – A state-permitted action or project within a stormwater-impaired water that a discharger or a third person may complete to mitigate the impacts that an existing or proposed discharge or discharges of regulated stormwater runoff has or is expected to have on the stormwater-impaired water.

OFFSET CHARGE – The amount of sediment load or hydrologic impact that an offset must reduce or control in the stormwater-impaired water in which the offset is located.

OFFSET CHARGE CAPACITY – The amount of reduction in sediment load or hydrologic impact that an offset project generates.

ONE YEAR STORM (Q_1) - A stormwater event which occurs on average once every year or statistically has a 100% chance on average of occurring in a given year.

ONE HUNDRED YEAR STORM (Q_{100}) A extreme flood event which occurs on average once every 100 years or statistically has a 1% chance on average of occurring in a given year.

OPEN CHANNELS - Also known as swales, grass channels, and biofilters. These systems are used for the conveyance, retention, infiltration and filtration of stormwater runoff.

OUTLET - The point at which water discharges from such things as a stream, river, lake, tidal basin, pipe, channel or drainage area.

OUTLET CHANNEL - A waterway constructed or altered primarily to carry water from man-made structures such as terraces, subsurface drains, diversions and impoundments.

PEAK DISCHARGE RATE - The maximum instantaneous rate of flow during a storm, usually in reference to a specific design storm event.

PERMANENT SEEDING - Results in establishing perennial vegetation that may remain on the area for many years.

PERMEABILITY - The rate of water movement through the soil column under saturated conditions

PERMISSIBLE VELOCITY (HYDRAULICS) - The highest average velocity at which water may be carried safely in a channel or other conduit. The highest velocity that can exist through a substantial length of a conduit and not cause scour of the channel. A safe, non-eroding or allowable velocity.

PERSON - Any individual, partnership, company, corporation, association, joint venture, trust, municipality, the state of Vermont or any agency, department or subdivision of the state, any federal agency, or any other legal or commercial entity.

pH - A number denoting the common logarithm of the reciprocal of the hydrogen ion concentration. A pH of 7.0 denotes neutrality, higher values indicate alkalinity, and lower values indicate acidity.

PIPING - Removal of soil material through subsurface flow channels or "pipes" developed by seepage water.

PLUGS - Pieces of turf or sod, usually cut with a round tube, which can be used to propagate the turf or sod by vegetative means.

POCKET POND - A stormwater pond designed for treatment of small drainage area (< 5 acres) runoff and which has little or no baseflow available to maintain water elevations and relies on ground water to maintain a permanent pool.

POCKET WETLAND - A stormwater wetland design adapted for the treatment of runoff from small drainage areas (< 5 acres) and which has little or no baseflow available to maintain water elevations and relies on ground water to maintain a permanent pool.

POND BUFFER - The area immediately surrounding a pond that acts as filter to remove pollutants and provide infiltration of stormwater prior to reaching the pond. Provides a separation barrier to adjacent development.

POND DRAIN - A pipe or other structure used to drain a permanent pool within a specified time period.

PONDSCAPING - Landscaping around stormwater ponds that emphasizes native vegetative species to meet specific design intentions. Species are selected for up to six zones in the pond and its surrounding buffer, based on their ability to tolerate inundation and/ or soil saturation.

POROSITY - Ratio of pore volume to total solids volume.

PRETREATMENT - Techniques employed in stormwater STPs to provide storage or filtering to help trap coarse materials before they enter the system.

PRINCIPAL SPILLWAY - The primary pipe or weir that carries baseflow and storm flow through the embankment.

PROJECT - New development, expansion, redevelopment and or existing impervious surface that the Secretary is considering for coverage under an individual or general permit or which has received coverage under an individual or general permit.

RECHARGE RATE - Annual amount of rainfall that contributes to groundwater as a function of hydrologic soil group.

REDEVELOPMENT - The reconstruction of an impervious surface where an impervious surface currently exists, when such reconstruction involves substantial site grading, substantial subsurface

excavation, or modification of existing stormwater conveyance such that the total of impervious surface to be constructed or reconstructed is greater than the minimum regulatory threshold. Redevelopment does not mean management activities on impervious surfaces, including any crack sealing, patching, coldplaning, resurfacing, paving a gravel road, reclaiming, or grading treatments used to maintain pavement, bridges and unpaved roads. Redevelopment does not include expansions.

REGULATED STORMWATER RUNOFF - precipitation, snowmelt, and the material dissolved or suspended in precipitation and snowmelt that runs off impervious surfaces and discharges into surface waters or into groundwater via infiltration.

RETENTION - The amount of precipitation on a drainage area that does not escape as runoff. It is the difference between total precipitation and total runoff.

REVERSE-SLOPE PIPE - A pipe which draws from below a permanent pool extending in a reverse angle up to the riser and which determines the water elevation of the permanent pool.

RIGHT-OF-WAY - Right of passage, as over another's property. A route that is lawful to use. A strip of land acquired for transport or utility construction.

RIP-RAP - Broken rock, cobbles, or boulders placed on earth surfaces, such as the face of a dam or the bank of a stream, for protection against the action of water (waves); also applies to brush or pole mattresses, or brush and stone, or similar materials used for soil erosion control.

RISER - A vertical pipe that extends from the bottom of a pond STP and houses the control devices (weirs/orifices) to achieve the discharge rates for specified designs.

ROUGHNESS COEFFICIENT (HYDRAULICS) - A factor in velocity and discharge formulas representing the effect of channel roughness on energy losses in flowing water. Manning's "n" is a commonly used roughness coefficient.

RUNOFF (HYDRAULICS) - That portion of the precipitation on a drainage area that is discharged from the area in the stream channels. Types include surface runoff, ground water runoff or seepage.

RUNOFF COEFFICIENT (R_v) - A value derived from a site impervious cover value that is applied to a given rainfall volume to yield a corresponding runoff volume.

SAFETY BENCH - A flat area above the permanent pool and surrounding a stormwater pond designed to provide a separation from the pond pool and adjacent slopes.

SAND - 1. (Agronomy) A soil particle between 0.05 and 2.0 millimeters in diameter. 2. A soil textural class. 3. (Engineering) According to the Unified Soil Classification System, a soil particle larger than the No. 200 sieve (0.074mm) and passing the No. 4 sieve (approximately 1/4 inch).

SECRETARY - the Secretary of the Agency of Natural Resources or the Secretary's duly authorized representative.

SEDIMENT - Solid material, both mineral and organic, that is in suspension, is being transported, or has been moved from its site of origin by air, water, gravity, or ice and has come to rest on the earth's surface either above or below sea level.

SEEPAGE - 1. Water escaping through or emerging from the ground. 2. The process by which water percolates through the soil.

SEEPAGE LENGTH - In sediment basins or ponds, the length along the pipe and around the anti-seep collars that is within the seepage zone through an embankment.

SETBACKS - The minimum distance requirements for location of a structural STP in relation to roads, wells, septic fields, other structures.

SHEET FLOW - Water, usually storm runoff, flowing in a thin layer over the ground surface.

SIDE SLOPES (ENGINEERING) - The slope of the sides of a channel, dam or embankment. It is customary to name the horizontal distance first, as 1.5 to 1, or frequently, 1 ½: 1, meaning a horizontal distance of 1.5 feet to 1 foot vertical.

SILT - 1. (Agronomy) A soil separate consisting of particles between 0.05 and 0.002 millimeter in equivalent diameter. 2. A soil textural class. 3. (Engineering) According to the Unified Soil Classification System a fine-grained soil (more than 50 percent passing the No. 200 sieve) that has a low plasticity index in relation to the liquid limit.

SITE - Either the drainage area that includes all portions of a project contributing stormwater runoff to one or more discharge points; or, the area that includes all portions of disturbed area within a project contributing stormwater runoff to one or more discharge points. The choice of either of these two methods of calculating the site area shall be at the discretion of the designer. In cases where there are multiple discharges to one or more waters, "site" shall mean the total area of the sub-watersheds. For linear projects, including but not limited to highways, roads and streets, the term "site" includes the entire right of way within the limits of the proposed work, or all portions of disturbed area within the right of way associated with the project. The method of calculating the site area for linear projects shall be at the discretion of the designer. Calculations of a site are subject to the Secretary's review under Section 18-303 of this Rule.

SOIL TEST - Chemical analysis of soil to determine needs for fertilizers or amendments for species of plant being grown.

SPILLWAY - An open or closed channel, or both, used to convey excess water from a reservoir. It may contain gates, either manually or automatically controlled to regulate the discharge of excess water.

STABILIZATION - Providing adequate measures, vegetative and/or structural that will prevent erosion from occurring.

STAGE (HYDRAULICS) - The variable water surface or the water surface elevation above any chosen datum.

STAND-ALONE OFFSET PROJECT – An offset project that is implemented by a person independent of the permitting of a discharge of regulated stormwater runoff.

STAND-ALONE OFFSET PROJECT NPDES PERMIT – A NPDES permit issued by the Secretary for a stand-alone offset project that is not completed prior to the initiation of the first discharge to which the offset charge capacity is assigned. A stand-alone offset project NPDES permit will be issued by the Secretary pursuant to the Agency's federally-authorized NPDES program under 10 V.S.A. Section 1258.

STILLING BASIN - An open structure or excavation at the foot of an outfall, conduit, chute, drop, or spillway to reduce the energy of the descending stream of water.

STORMWATER DISCHARGE PERMIT OR STORMWATER PERMIT - A permit issued by the Secretary for the discharge of regulated stormwater runoff to waters that are not stormwater-impaired waters.

STORMWATER FILTERING - Stormwater treatment methods that utilize an artificial media to filter out pollutants entrained in urban runoff.

STORMWATER IMPACT FEE – The monetary charge assessed to a permit applicant for the discharge of regulated stormwater runoff to a stormwater-impaired water that mitigates a sediment load level or hydrologic impact that the discharger is unable to control through on-site treatment or completion of an offset on a site owned or controlled by the permit applicant.

STORMWATER-IMPAIRED WATER - A state water listed as being impaired principally due to stormwater runoff on the EPA-approved State of Vermont 303(d) List of Waters.

STORMWATER-IMPAIRED WATERSHED – The total area of land contributing runoff to a stormwater-impaired water.

STORMWATER PONDS - A land depression or impoundment created for the detention or retention of stormwater runoff.

STORMWATER RUNOFF - Precipitation and snowmelt that does not infiltrate into the soil, including material dissolved or suspended in it, but does not include discharges from undisturbed natural terrain or wastes from combined sewer overflows.

STORMWATER WETLANDS - Shallow, constructed pools that capture stormwater and allow for the growth of characteristic wetland vegetation.

STREAM BUFFERS - Zones of variable width that are located along both sides of a stream and are designed to provide a protective natural area along a stream corridor.

STREAM CHANNEL PROTECTION (CP_v) - A design criteria which requires either 12 or 24 hour detention of the one year postdeveloped, 24 hour storm event for the control of stream channel erosion.

STRUCTURAL STPs - Devices that are constructed to provide temporary storage and treatment of stormwater runoff.

STRUCTURES – Buildings such as houses, businesses, pump houses, and storage sheds and infrastructure such as roadways, culverts, bridge abutments, and utilities.

SUBGRADE - The soil prepared and compacted to support a structure or a pavement system.

SUBSTANTIALLY DETERIORATED - The condition of a stormwater treatment practice that would necessitate repair or reconstruction beyond that which would be considered routine, periodic maintenance for a system of similar design.

TAILWATER - Water, in a river or channel, immediately downstream from a structure.

TECHNICAL RELEASE No. 20 (TR-20) - A Soil Conservation Service (now NRCS) watershed hydrology computer model that is used to compute runoff volumes and route storm events through a stream valley and/or ponds.

TECHNICAL RELEASE No. 55 (TR-55) - A watershed hydrology model developed by the Soil Conservation Service (now NRCS) used to calculate runoff volumes and provide a simplified routing for storm events through ponds.

TEMPORARY SEEDING - A seeding which is made to provide temporary cover for the soil while waiting for further construction or other activity to take place.

TEN YEAR STORM (Q₁₀) - The peak discharge rate associated with a 24 hour storm event which exceeds bankfull capacity and occurs on average once every ten years (or has a likelihood of occurrence of 10% in a given year).

TIME OF CONCENTRATION - Time required for water to flow from the most remote point of a watershed, in a hydraulic sense, to the outlet.

TOE (OF SLOPE) - Where the slope stops or levels out. Bottom of the slope.

TOE WALL - Downstream wall of a structure, usually to prevent flowing water from eroding under the structure.

TOPSOIL - Fertile or desirable soil material used to top dress road banks, subsoils, parent material, etc.

TOTAL MAXIMUM DAILY LOAD or TMDL – The calculations and plan for meeting water quality standards approved by the U.S. Environmental Protection Agency (EPA) and prepared pursuant to 33 U.S.C. 1313(d) and federal regulations adopted under that law.

TOTAL SUSPENDED SOLIDS - The total amount of soils particulate matter that is suspended in the water column.

TRACT OR TRACTS OF LAND - A portion of land with defined boundaries created by a deed. A deed may describe one or more tracts.

TRASH RACK - Grill, grate or other device at the intake of a channel, pipe, drain or spillway for the purpose of preventing oversized debris from entering the structure.

TWO YEAR STORM (Q_2) - The peak discharge rate associated with a 24 hour storm event which exceeds bankfull capacity and occurs on average once every two years (or has a likelihood of occurrence of 1/2 in a given year).

ULTIMATE CONDITION - Full watershed build-out based on existing zoning. Where zoning has not been established, ultimate condition should reflect reasonable professional judgment that considers the likely nature of land use for the subject lands projected out over a 30 to 40 year planning period. Review authorities should be consulted where zoning has not been established.

ULTRA-URBAN - Densely developed urban areas in which little pervious surface exists.

VELOCITY HEAD - Head due to the velocity of a moving fluid, equal to the square of the mean velocity divided by twice the acceleration due to gravity (32.16 feet per second per second).

VERMONT STORMWATER MANAGEMENT MANUAL - The Agency of Natural Resources' stormwater management manual.

VOLUMETRIC RUNOFF COEFFICIENT (R_v) - The value that is applied to a given rainfall volume to yield a corresponding runoff volume based on the percent impervious cover in a drainage basin.

WATER QUALITY REMEDIATION PLAN or WQRP – A plan, other than a TMDL or sediment load allocation, designed to bring an impaired water body into compliance with applicable water quality standards in accordance with 40 C.F.R. 130.7(b)(1)(ii) and (iii).

WATER QUALITY VOLUME (WQ_v) - The storage needed to capture and treat 90% of the average annual stormwater runoff volume.

WATER SURFACE PROFILE - The longitudinal profile assumed by the surface of a stream flowing in an open channel; the hydraulic grade line.

WATERSHED - The total area of land contributing runoff to a specific point of interest within a receiving water.

WATERSHED IMPROVEMENT PERMIT – A general permit specific to a stormwater-impaired water that is designed to apply management strategies to existing and new discharges and that includes a schedule of compliance of no longer than five years reasonably designed to assure attainment of the Vermont water quality standards in the receiving waters.

WEDGES - Design feature in stormwater wetlands, which increases flow path length to provide for extended detention and treatment of runoff.

WET SWALE - An open drainage channel or depression, explicitly designed to retain water or intercept groundwater for water quality treatment.

WETTED PERIMETER - The length of the line of intersection of the plane or the hydraulic cross-section with the wetted surface of the channel.

WING WALL - Sidewall extensions of a structure used to prevent sloughing of banks or channels and to direct and confine overfall.

303(D) LIST - The EPA-approved State of Vermont 303(d) List of Waters prepared pursuant to 33 U.S.C. 1313(d).

REFERENCES

- Caraco, D. and R. Claytor. 1997. Stormwater BMP design supplement for cold climates. Center for Watershed Protection. Ellicott City, MD
- City of Austin, TX. 1988. Water Quality Management. In, Environmental Criteria Manual. Environmental and Conservation Services. Austin, TX.
- Claytor, R. and T. Schueler. 1996. Design of Stormwater Filtering Systems. Center for Watershed Protection. Ellicott City, MD.
- Cappiella, K. and K. Brown. 2001. Impervious Cover and Land Use in the Chesapeake Bay Watershed. Center for Watershed Protection, Ellicott City, Maryland.
- Galli, J. 1990a. Thermal impacts associated with urbanization and stormwater management best management practices. Metropolitan Washington Council of Governments. Maryland Department of Environment. Washington, D.C. 188 pp.
- Galli, J. 1990b. Peat-Sand Filters: A Proposed Stormwater Management Practice for Urbanized Areas. MWWCOG. Washington, DC.
- Harrington, B.W. 1987. Design Procedures for Stormwater Management Extended Detention Structures. Report to Water Resources Administration. Maryland Department of Natural Resources. Annapolis, MD.
- National Oceanic and Atmospheric Administration. 1961. Rainfall Frequency Atlas of the United States Technical Paper 40. 115 pp.
- Natural Resources Conservation Service. 1986. Urban Hydrology for Small Watersheds. Technical Release No. 55. USDA. Washington D.C.
- Natural Resources Conservation Service. 1984. Engineering Field Manual for Conservation Practices. USDA. Washington D.C.
- Natural Resources Conservation Service. 1982. Project Formulation-Hydrology. Technical Release No. 20. USDA. Washington D.C.
- Oberts, G. 1994. Influence of snowmelt dynamics on stormwater runoff quality. *Watershed Protection Techniques*. 1(2):55-61.
- Schutes, R.B, J.B. Ellis, D.M. Revitt, and T.T. Zhang. 1993. "The Use of *Typha latifolia* for Heavy Metal Pollution Control in Urban Wetlands." *Constructed Wetlands for Water Quality Improvement*. Ed. G.A. Moshiri, CRC Press.
- US Environmental Protection Agency. 1993. Guidance Specifying Management Measures for Sources of Nonpoint Pollution in Coastal Waters. EPA-840-B-92-002. U.S. EPA, Office of Water, Washington, DC
- Vermont Water Resources Board. 2000 or Current Version. Vermont Water Quality Standards. Montpelier, VT
- Washington State Department of Ecology. 1992. Stormwater Management Manual for the Puget Sound Basin (Technical Manual).